

Pharmacy Refrigerator

Operation Manual

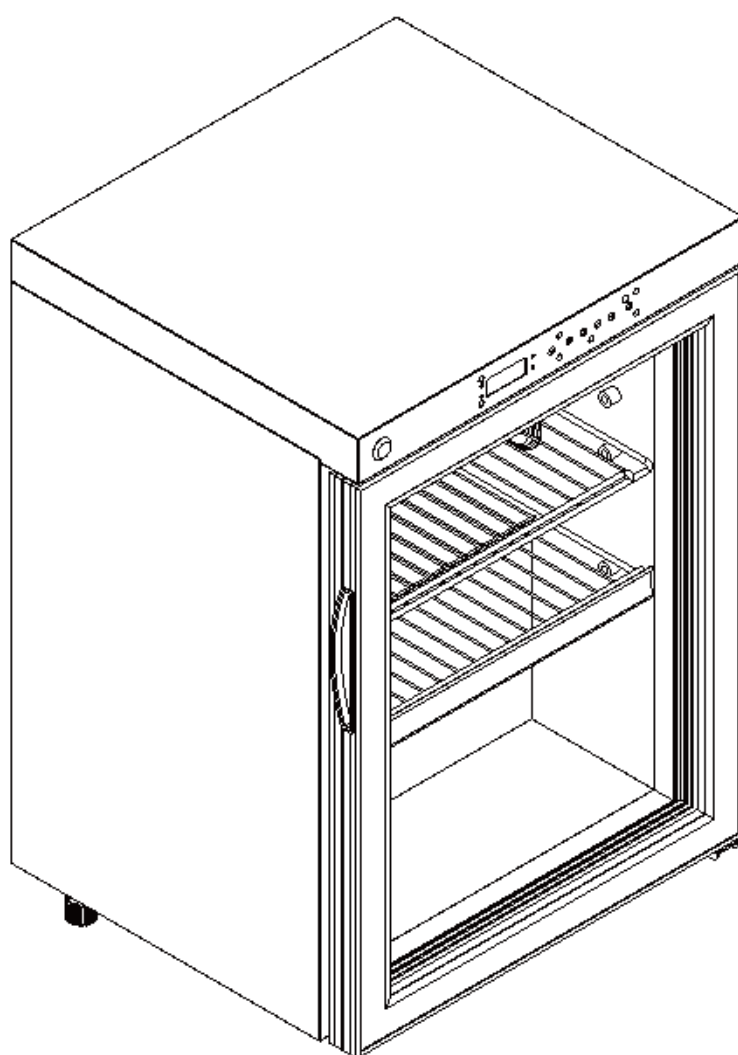

SPR-68

Statement:

Thank you for choosing and using our medical refrigerator. For your safe and convenient use and reasonable maintenance of the product, please read the operation instruction carefully and keep it properly for reference. For damage of any instrument due to the fact that the user does not use the product according to the instrument operating environment declared in the handbook or injuries due to the fact that individual does not operate the product according to safety instructions, we has no obligations and responsibilities to be in charge of them.

The user must accomplish the following three points when using the product:

1. Always use protective devices correctly (including clothes, gloves, goggles, etc.);
2. Always adopt good health habits and operate strictly according to the product instruction;
3. Everyone is obliged to be in charge of one' own safety.
4. Not Allowed direct contact with patients, use or affect the product and in the product storage items.
5. Products without sterilization.
6. The product is used only for storage, not during use with other materials, Organization and Technology in combination.
7. Products can not be used to measure or analysis.
8. Life and storage life of the products is irrelevant.
9. Some models need to regularly add supplies, such as printer paper, test tubes, etc.
10. This product is non-explosion-proof products.
11. Non flash freeze equipment, is limited to keeping the temperature used.

Due to the fast product update, there may be differences between function of the product you bought and the function mentioned in the instruction, please in kind prevail.

Safety Instruction:

- ☒ Please read the handbook carefully when using the machine for the first time.
- ☒ The medical refrigerator can only be operated by trained and authorized personnel.
- ☒ The maintenance of the equipment can only be accomplished by us or agents authorized by us.
- ☒ If operator runs into conditions not mentioned in the instruction, please contact us or agents authorized by us for inquiring correct processing method.
- ☒ Please use accessories provided by us, if user uses other accessories, we will not take charge of generated negative effects. however, the user can apply to us to test and verify that whether the accessories accord with the requirements.
- ☒ It is necessary to inspect and maintain the medical refrigerator at specified time intervals.
- ☒ The medical refrigerator is strictly prohibited to store living things or other goods which have strict temperature Requirement and are unsuited for storage at constant temperature.
- ☒ The medical refrigerator realizes refrigeration through the heat dissipation of the back surface (condenser). In order to ensure normal operation and ventilation and heat dissipation, the back and the left and right sides of the refrigerator body should be at least 30cm away from the wall and no barriers are allowed to block the air inlet and the air outlet.
- ☒ In case of machine fault or power failure, the temperature in the medical refrigerator will rise. If the machine cannot be repaired in short period, please take out the stored goods and transfer them to other place where accords with the storing temperature to avoid damage.



- ☒ : It is used to warn the user that there may be a danger of pinching hands in the gap of product door when opening and closing



- ☒ : It is used to warn the users that electrical components and connecting wire terminals in the cabin may be in danger of electric shock



- ☒ : Used to warn users that products should stay away from fire sources



- ☒ : Used to warn users that the product fan may be in danger of hurting hands when taking items.

Contents

I. Diagram and Introduction of Product	4
II. Preparation and Attention before Use	4
III. Instructions	6
3.1 First use	6
3.2 Temperature regulation	7
3.2.1 Key function	7
3.2.2 Parameter settings	8
3.2.3 Temperature query settings	8
3.2.4 Time query settings	8
3.2.5 Alarm code	9
3.2.6 Error display	9
IV. Routine Maintenance	11
4.1 Clean of Refrigerator	11
4.2 Defrost	11
4.3 Care and Maintenance	11
V. Clearing of Fault and Maintenance Service	12
VI. Main Performance Index	13
6.1 Main technical parameters	13
6.2 Electrical schematic diagram	13
VII. Packing List	13

I. Diagram and Introduction of Product

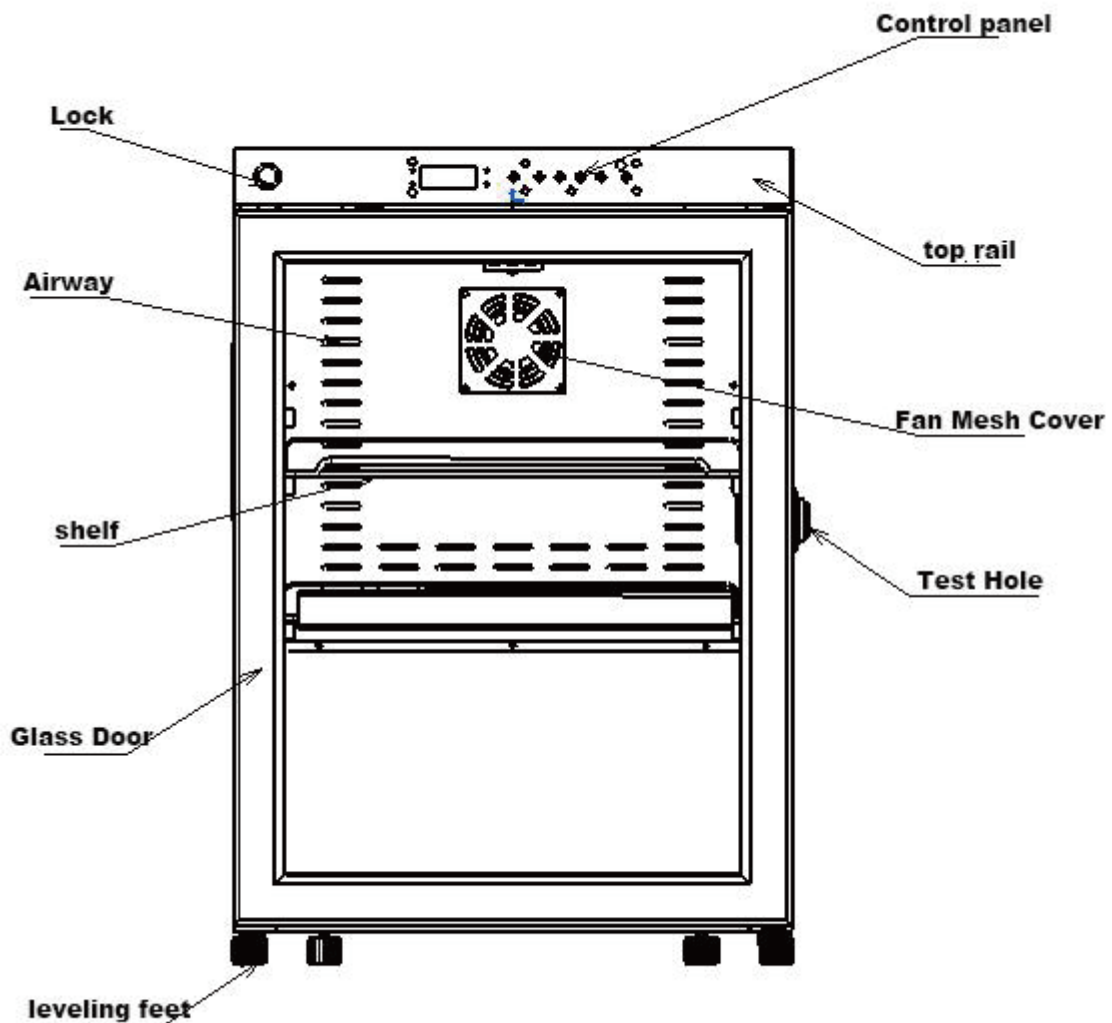

Structural Diagram

Due to the improvement and various models of products, the actual product may be different from the diagram, please in kind prevail!

Medical refrigerator series products are applied to places needing storage at constant temperature for commercial use, The storing temperature in the body can be regulated by the temperature button on the control panel. The application is convenient and the performance is reliable.

II. Preparation and Attention before Use

- ☒ Transport: the refrigerator should be uplifted from the bottom when carried and put down lightly. The inclined plane should be no larger than 45 degrees.
- ☒ After installation, keep the device standing for 12 hours at least to return the compressor oil.
- ☒ Do not hold the door or the frame as stressed point

- Dismantle all package components (including protection foam in the refrigerator body).
- Please check accessories and data according to the packing list.
- Please clean the product before use.
- Operating environment requirements:
 - a. For indoor use only;
 - b. The mounting surface must be fixed, horizontal and incombustible and be able to bear weight during the operation of the medical refrigerator;
 - c. To be placed away from direct glare of sunshine and heat and the environmental temperature should be not more than 32°C;
 - d. Space of above 30cm is required to be left around the medical refrigerator for ventilation and heat dissipation;
 - e. Not allowed to be placed in the environment under 0°C;
 - f. Not allowed to be placed at places with heavy moisture or easy-splashing water.
 - g. Ambient non corrosive, flammable, explosive gas, liquid or dust.
 - h. The surrounding environment must be kept well ventilated.
- On flat ground, the medical refrigerator can be directly pushed to move.

⚠ Notes: please note that do not let the power line be damaged by trundles when pushing the medical refrigerator.

⚠ Notes: be sure to take off the packaging pedestal on the bottom of the medical refrigerator.

⚠ Notes: Do not put goods into the medical refrigerator which is just plugged in. Let the empty body run for a while (about 12 hours) and then put the goods to be refrigerated into the refrigerator.

- Normal operating condition of the equipment:
 - a. Environmental temperature: 10°C—32°C;
 - b. Relative humidity: ≤80%;
 - c. There is no strong sharp pounding and corrosive gas around;
 - d. There are no effects of direct radiation of sunshine and other cold and heat sources.

Working system of the medical refrigerator: intermittent running

Safety precautions

- Supply voltage: the equipment needs 220V/50Hz alternating current power supply. If the service voltage is lower than 187V or higher than 242V, it is necessary to add a proper automatic voltage regulator to be used cooperatively;
- When the medical refrigerator is used, the power supply is required to be equipped with a lower voltage air circuit breaker and a leakage protection device;
- It is necessary to use a dedicated independent socket which is grounded reliably. The length of the power line cannot be lengthened at randomly. If it really needs to be lengthened, be sure to use a copper core conductor which is larger than 2.5mm². And the cross area of the copper core conductor which is in the wall and connected with the power socket must be above 4mm²;
- Inflammable and explosive dangerous goods and goods of acid and alkali etc. with strong corrosiveness

are not allowed to be put into the medical refrigerator;

- Keys should be kept properly to avoid accidents that will happen if children get the key to open the door;
- The zero line (N end) of the socket cannot be connected with the ground lead (E end). Otherwise, the housing of the medical refrigerator may be electrified and electric shock accidents may be caused;
- The power line cannot be bundled up, pressed under weight and next to heat sources of compressor, etc.

III. Instructions

3.1 First use

- After being unpacked, the medical refrigerator should be placed well to according to the service environment requirement;
- Although the refrigerator has been cleaned inside when leaving factory, it is advised to scrub the medical refrigerator with warm water added with a little neutral detergent and then scrub it with clean water and wipe it up (electrical system cannot be cleaned but scrubbed with dry cloth);
- Set the temperature controller of the medical refrigerator at 5°C and turn on the power. After 3 minutes, the compressor is started. After 30 minutes, the temperature inside the medical refrigerator decreases obviously. It means the refrigerating system is operating smoothly and the machine test is finished;
- For first use, it is advised to put the goods to be stored in the refrigerator after the inside temperature falls to the operating temperature. If there are too much goods to be stored, it is advised to store separately for three times. When the inside temperature of the refrigerator falls to the set temperature after the storage of the last time, store the goods for the second time. Storing too much goods at one time may cause that the refrigerator cannot fall to the set temperature for a long time, thereby causing damages of goods;
- In order to save electrical energy, please try to reduce door-opening frequency and open time.

3.2 Temperature regulation

3.2.1 Key function



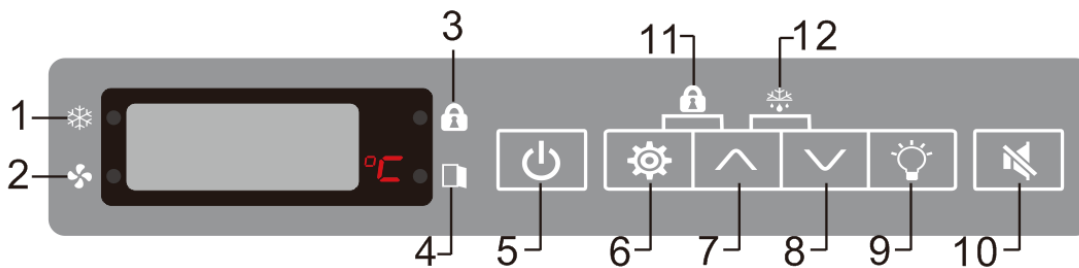

The electric temperature controller is installed on the control panel of the medical refrigerator. When power is on, the digital display screen can display the actual temperature inside the refrigerator. The control panel of the temperature controller is illustrated by the following diagram:



- 1.Cooling status indicator
- 2.Fan status indicator
- 3.Keyboard lock indicator
- 4.Door open indicator
- 5.Power switch
- 6.Setting
- 7.Up
- 8.Down
- 9.Lamp switch
- 10.Mute
- 11.Keyboard lock (Combination)
- 12.Defrost (Combination)
- Please do not change the settings during normal using.
- Long press the power key will switch off the refrigerator. Long press the power button again, the refrigerator will work again.
- Long press the keypad lock key (combination of keys) can lock the keypad. The keyboard lock LED are lit, all the keys are locked. Then long press the keypad lock again can be unlocked.
- Press “Mute” to stop buzzing if necessary, but the alarm indicator and code still display until the alarm disappear.
- For special using, please contact our authorized service engineer before adjust the settings. Wrong operation may cause abnormal working of the device, such as bad temperature uniformity and abnormal high/low temp alarm.
- Notes: the general high and low temperature alarm values are within the set temperature range of 2~10 °C.

3.2.2 Parameter settings









When power on the medical refrigerator, the display screen displays internal temperature value. To change setting temperature, for example, the original set temperature is 2°C which now has to be adjusted to 5°C, please operate according to the following steps:

Serial No.	Keys Operation	Display
1		Displays the inside temperature
2	Press the key Set  for 3 seconds	Displays the initial set data is 2°C and twinkles
3	Press the key Up-regulation 	Figure increases
4	Press the key Down-regulation 	Figure decreases
5		Figure is 5°C
6	Press the key Set  for 3 seconds	Saves the user settings and displays the inside temperature

Notes: If other parameter need to be changed, please contact after-sale or local distributor of us for setting.

3.2.3 Temperature query settings

When normal working, press  check high and low temperature record. Such as current time is 9:20on the afternoon of Mar 15th, 2017 record the high temperature of 6.7 °C ,at 15;23 record the low temperature of 3.9°C, and the cycle. No operation is larger than that of 5S showed normal temperature. The query is shown below:

NO.	key operation	Display
1		Display cabinet temperature
2	press 	Display highest temperature6.7°C
3	Press again 	Display HT date HD20
4	Press again 	Display HT hour HH09
5	Press again 	Display HT minute HE30
6	Press again 	Display lowest temperature3.9
7	Press again 	Display LT date LD20
8	Press again 	Display LT hour LH14
9	Press again 	Display LT minute LE25
10	Press again 	Display highest temperature6.7°C

Note: When normal display long press  5s,to delete a record high and low temperature data, check high and low temperature data at this time, showing “ 00 ” ,time display code +00,such as “HD00”.The current data logging time interval is 10min, the default is 17:35 minutes to clear records of high and low temperature data.

3.2.4 Time query settings

When normal working, press  check time record, such as current time is 20:20.21 on the afternoon of Mar

15th, 2017.

NO.	key operation	Display
1		display cabinet temperature.
2	Press	Year Y_17
3	press again	Month N_03
4	press again	Date D_15
5	press again	Minute E_20
6	press again	Sencon S_21

Note: When normal display long press 5s, can adjust the current time. When normal display, press 5s, flickering display of Y_17, through press or set current year, then press flickering display of N_03, through or set the current month, repeat these steps after you have set the time accordingly, long time press can save time settings.

3.2.5 Alarm code

Alarm code	Describe	Alarm code	Describe
AH	Cabinet high temperature alarm	AS1S	Control probe 1 shorted
AL	Cabinet low temperature alarm	AS1B	Control probe 1 broken circuit
ADO	Door ajar alarm	AD1S	Defrosting _ probe display broken circuit
AUF	Power failure alarm	AD1B	Defrosting _ probe display broken circuit
ABL	Low Battery		

➤ After the power is switched off, the control function of the controller fails and the back-up source is used for displaying. If the back-up source is charged for more than 10 hours, the power failure symbol “AUF”, the current inside temperature and the alarm display alternatively for one time and then display again after 1min stop for cycle operation. After 8 hours, the nixie tube stops displaying. The power failure alarm light will 5S twinkle continuously until the electric quantity of the back-up source is used up. The inside temperature can be continuously displayed during the power failure. Please pay attention to this and take relevant measures to avoid damage.

3.2.6 Error display

- When faults of the refrigerator temperature display sensor including short circuit, open circuit, malfunction and incorrect connection appear, “ AD1S ” is displayed. When faults of the refrigerator temperature control sensor including short circuit, open circuit, malfunction and incorrect connection appear, “AS1S” is displayed. At the same time, the buzzer of the temperature controller will give out alarm and the display screen displays corresponding alarm parameters (AD1S、 AS1S).
- After the power is switched off, the control function of the controller fails and the back-up source is used for displaying. If the back-up source is charged for more than 10 hours, the power failure symbol “ AUF ”, the current inside temperature and the alarm display alternatively for one time and then display again after 1min stop for cycle operation. After 8 hours, the nixie tube stops displaying. The power failure

alarm light will 5S twinkle continuously until the electric quantity of the back-up source is used up. The inside temperature can be continuously displayed during the power failure. Please pay attention to this and take relevant measures to avoid damage.

- Suggest: If you judge that the temperature sensor goes wrong, you should cut off the power and first check whether the connecting wire of the sensor is loose. Please contact professional after-sales service or distributor of us for processing.

! Tips: if internal code appears when user regulates the temperature controller, the user should wait for 1 minute and then operate it till the inside temperature is displayed to avoid fault of the medical refrigerator caused by the changing of the control parameter.

- When the medical refrigerator stops temporarily due to power failure or other faults, the inside temperature of the medical refrigerator will rise from 5°C to 15°C within 1 hour. If power cannot be supplied in short time, the user should consider taking out the stored goods and putting them into other normal medical refrigerators for storing to avoid losses caused by the damage of the stored goods.
- Before putting goods into the medical refrigerator to be stored, the user should confirm in advance that whether inside temperature of the medical refrigerator is in accordance with the set temperature for storing to avoid losses caused by goods damage due to the improper temperature.
- Due to the refrigeration inertia, the medical refrigerator cannot be kept at constant temperature. And there is certain up and down difference between the inside temperature and the set temperature. The inside temperature varies with the changing of the environmental conditions and the temperature set. It belongs to normal phenomenon.

IV. Routine Maintenance

In routine maintenance, in order to prevent electric shock or personnel injuries, be sure to cut off the power before repairing or maintaining the equipment and do not inhale drugs or particulate matters surrounding the equipment when maintaining the equipment. It is necessary to have dry gloves to protect your hands. Otherwise, your hands may be cut by edges or corners of the refrigerator body.

4.1 Clean of Refrigerator

- ☒ The medical refrigerator should be cleaned for once every month. Regular cleaning may keep the appearance of the refrigerator new;
- ☒ Use dry cloth to wipe off a small amount of dust on the surface, the interior and all accessories of the medical refrigerator. If the medical refrigerator is very dirty, it is advised to use neutral detergent for cleaning;
- ☒ After cleaning, use cloth which has been soaked in clean water to wipe off the detergent;
- ☒ Do not pour water on the surface or inside of the medical refrigerator. Otherwise, the electrical insulation may be damaged, thereby causing malfunction.
- ☒ During the rainy season, vapors may be easily condensed on the surface of the glass door of the refrigerator, water may drip in bad condition. Please use dry cloth to wipe it at the proper time. Normal use will not be affected.

4.2 Defrost

The medical refrigerator belongs to air cooling frost-less refrigerator. In summer with high environmental humidity, condensation may appear on the buccal frame of the medical refrigerator. This is normal. It is advised to wipe it with dry cloth.

4.3 Care and Maintenance

- ☒ Don't put heavy stuff on the door or top cap in order to avoid deformation of stress
- ☒ The medical refrigerator should be cleaned and maintained at set intervals.
- ☒ Use warm wet soft cloth to wipe the inner and outer surfaces of the medical refrigerator.
- ☒ If especially dirty, use neutral detergent for washing tableware to wipe and then use cleaned soft cloth to wipe out the water spots.
- ☒ Once starting the medical refrigerator, you'd better keep it running continuously.

! **Notes: Never splash water directly onto the storage refrigerator as this may cause electric shock or short circuit. Never use hot water and corrosive detergent or organic solvent to clean. Never clean the medical refrigerator with scrubbing brush and wire brush. Keep children away from the equipment.**

V. Clearing of Fault and Maintenance Service

Some abnormal conditions of the medical refrigerator are caused by improper operation. Before you commit maintenance, please compare with following table for self-inspection and exclusion.

Problems	Reasons and Solving Measures
medical refrigerator does not work	<ul style="list-style-type: none"> ·If the power socket has electricity? ·If the power socket is plugged or loosened? ·If the power fuse is disconnected? ·If the supply voltage is too low or too high?
Compressor breaks down	<ul style="list-style-type: none"> ·If the temperature setting is right?
Temperature goes on decreasing after reaching to the set data	<ul style="list-style-type: none"> ·If the temperature setting is right?
Temperature can't reach the set data	<ul style="list-style-type: none"> ·If the fan stops running? ·If the door is not closed tight or opened too frequently? ·If too many goods are put in at one time and if the air channel is blocked? ·If the environmental temperature is too high?
Too much noise	<ul style="list-style-type: none"> ·If the refrigerator body is stayed on the flat ground? ·If the refrigerator body touches the wall? ·If the refrigerator immediately enters operating status after being started?

If you can't judge the fault cause or debug, please contact the local or nearby special maintenance station according to the instruction of the warranty certificate (standard accessory) and tell use your name, address, phone number, type of the medical refrigerator, purchasing time, fault phenomenon, etc. Professional engineer will offer warmhearted service to you.

VI. Main Performance Index

6.1 Main technical parameters

Model	Temp	Volume	Power supply	Refrigerant	Dimension
SPR-68	2~8°C	68L	220V, 50Hz	R600a	490×441×710

6.2 Electrical schematic diagram

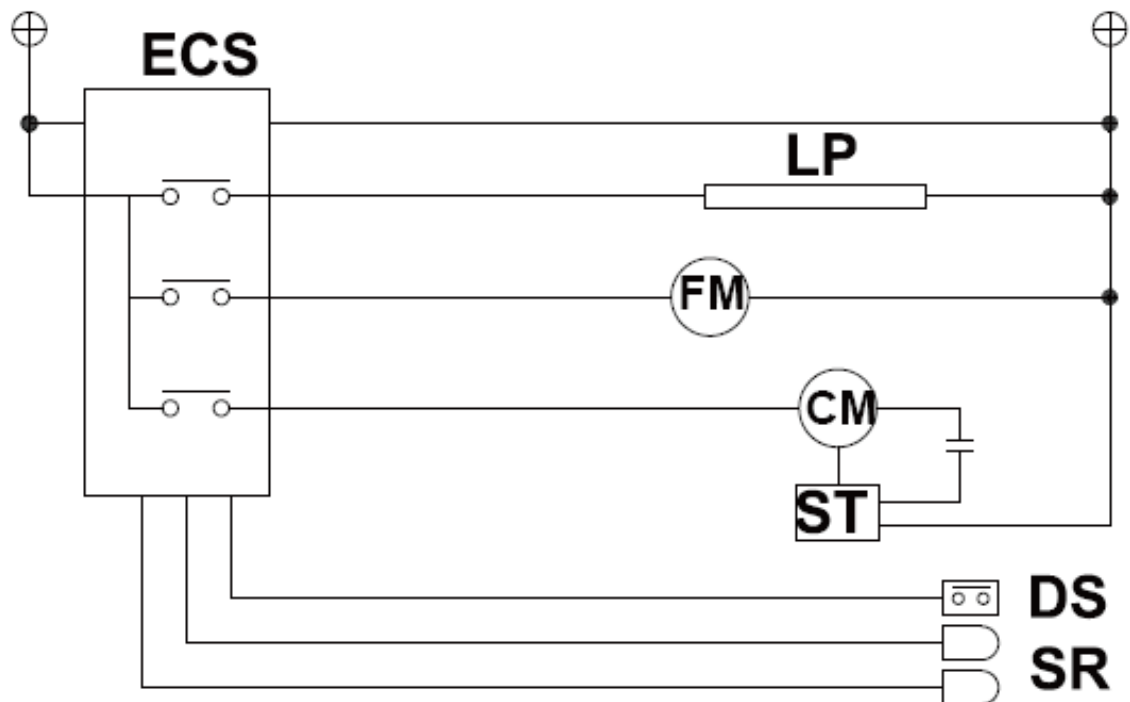

ECS=Thermostat

DS=Door switch

CM=Compressor

FM=Evaporation fan

LP=Fluorescent lamp

ST=Starting relay

SR=Sensor

VII. Packing List

Model	Manual	Key	Shelf	Price tag
SPR-68	1	2	2	2