

Pharmacy Refrigerator

Operation Manual

The following product models are applicable:

SPR-55S, SPR-135S,
SPR-315S, SPR-395S,
SPR-525S, SPR-1015S,

Table of Contents

1. Application Notes	1
2. Safety Instructions	2
3. Precautions in Use	4
4. Installation and Commissioning	4
4.1 Installation Environment	4
4.2 Installation Site	4
4.3 Preparation before Use	5
4.4 First Power-on	5
4.5 Operation after Power Failure	6
5. Product composition and overview	7
6. Operating Instructions	11
6.1 Function Introduction	11
6.2 Optional function	18
7. Maintenance and Service	20
7.1 Equipment Maintenance	20
7.2 Equipment Discontinuation	20
7.3 Maintenance, Replacement, and Recovery of Rechargeable Batteries	20
8. Troubleshooting and Maintenance Services	21
9. Specifications	22
10. Packing List	23
11. Electrical Schematic Diagram	23

1. Application Notes

Thank you for choosing and using Stalwart products! For your safe and convenient use and reasonable maintenance of the equipment, please read the Operation Instructions carefully before use and keep it properly for reference

The equipment operator can copy some chapters of this operation manual, but only for internal use, for example, to instruct the user how to deal with emergencies. These chapters are clearly marked in the catalog of the manual.

Stalwart has no obligation and responsibility for any instrument damage caused by the user's failure to use the equipment according to the instructions or the method specified by the manufacturer.

Due to the rapid improvement of Stalwart products, the functions described in the instructions may be inconsistent with those of the products you purchased. Please refer to the physical functions.























- ◆ Please read carefully the Attention and Safety Precautions (in 2. Safety Instructions).
- ◆ During transportation or use, no violent vibration or collision is allowed and the refrigerator shall be kept away from rain. Store in a clean room with humidity no more than 80 %, no corrosive gas and good ventilation.
- ◆ Pharmacy/Medical refrigerators (hereinafter referred to as equipment) can only be operated by trained and authorized personnel.
- ◆ Maintenance of the equipment can only be completed by Stalwart or a qualified agent authorized by Stalwart.
- ◆ If the operator encounters any situation not mentioned in this manual, please contact Stalwart or the agent authorized by Stalwart for the correct operation or service method.
- ◆ If the equipment is not used according to the method specified in the specification, it may be damaged.
- ◆ Try to use the accessories provided by Stalwart. If users would like to use other accessories, Stalwart has no be responsible for the adverse consequences caused therefrom.
- ◆ Equipment must be inspected and maintained regularly to ensure good operation of the equipment.











Tips









- ◆ Properly use protective equipment (including protective clothing, protective gloves, goggles, etc.)
- ◆ Keep good hygiene habits
- ◆ Please pay attention to safety when using this product
- ◆ Keep clear of obstruction all ventilation openings in the appliance enclosure or in the structure for building-in.
- ◆ Do not use mechanical devices or other means to accelerate the defrosting process, other than those recommended by the manufacturer.
- ◆ Do not damage the refrigerating circuit.
- ◆ Do not use electrical appliances inside the food/ice storage compartments unless they are of the type recommended by the manufacturer.

2. Safety Instructions

When using this product for the first time, please pay attention to the meaning of the following warning signs and carefully read the safety precautions, so that you can use this equipment safely and correctly.

 Warning! Failure to observe the precautions may result in serious personal injury or death.	 Attention! Failure to observe the precautions may result in personal injury or equipment failure and related property losses.	
 Protective conductor terminal.	 Risk of Explosion! This sign indicates the risk of explosion when using volatile and explosive chemicals.	
 Do not place it obliquely.	 Avoid direct sunlight.	
 Beware of electric shock.	 Beware of fire.	
 This equipment is a precision instrument	 Operating instructions	
 Manufacturer	 Series NO	 Date of production
 Warning: Failure to observe the precautions may result in serious personal injury or death.		
 Do not touch the equipment with wet hands to avoid electric shock; Equipment shall not be grounded through gas pipeline, water supply pipeline, telephone line or lightning rod, which may easily cause electric shock.		
 This equipment can only be installed by professional technicians or after-sales maintenance personnel, it may cause electric shock or fire.		
 Be sure to install the equipment on a solid and flat ground and take due care to prevent tipping over. If the ground is not solid enough or the installation location is not appropriate, it may cause the equipment to fall over and cause equipment damage or personal injury.		
 Please handle the power cord carefully to avoid short circuits or open circuits. Please turn off the power before pulling out the power plug. Hold the power plug carefully and pull it out. Do not pull the wires of the power plug. Otherwise, it may cause electric shock or fire due to the short circuit. Don't bundle the power cord, don't press it under furniture or heavy objects, and don't get close to heat sources such as compressors.		
 Please insert the power plug into the outlet tightly to ensure firmness and reliability, so as to avoid electric leakage; After installation, the power plug must be within reach, so that the power plug can be unplugged in time in case of emergency.		
 Separate special outlets must be used and grounded reliably. The cross-sectional area of the copper conductor in the wall connected with the outlet must be more than 4mm ² . Do not lengthen the power cord without authorization to avoid heating or fire.		
 Do not use the power supply that is not specified in the equipment design, so as to avoid overheating, short circuit and other faults. For example, connecting 110 V rated voltage products to 220 V power supply may cause faults such as overheating and equipment burning. This equipment adopts a 110V/60HZ AC power supply. If the operating voltage is too low or too high, a suitable automatic voltage stabilizer must be installed for cooperative use.		
 Please place the equipment stably and avoid shaking.		
 Do not place the equipment in a dangerous area, and do not operate the equipment near flammable items to prevent explosion or fire accidents.		

	Do not place the equipment in areas exposed to the sun or rain, so as to prevent danger such as short circuit or overheating.
	Do not tilt or lay the equipment sideways, and do not impact the equipment body; Refrigeration systems are installed in the equipment, which is easy to be damaged by tilt or impact.
	Please place the equipment in a dry and dust-free environment to avoid risks such as overheating, and short circuit.
	In case of unexpected sound, smell, smoke, etc. when the power is turned on, please unplug the power in time and contact the manufacturer or supplier.
	Please place the equipment in a dry and ventilated environment, and ensure that the equipment vents and instrument surfaces are not blocked or shielded by walls or other objects; Do not use it in a poorly ventilated environment to prevent damage caused by heat released by equipment.
	It is forbidden to disassemble and modify this equipment without authorization, so as to avoid potential safety hazards. In this case, Stalwart will not bear any responsibility for quality accidents.
	It is forbidden to put inflammable and explosive dangerous goods, strong corrosive acids, alkalis and other items unsuitable for the equipment in the equipment.
	When storing toxic, harmful or radioactive materials, please use the equipment in safe areas. Improper use may cause harm to human health or environment.
	Metal objects such as nails or iron wires shall not be inserted into any aperture and gap or any outlet of the equipment, otherwise electric shock or injury may be caused due to accidental contact between the above objects and moving parts.
	In order to ensure the normal operation and ventilation and heat dissipation of the equipment, the back, left and right sides of the cabinet shall be at least 30cm away from the wall, and the air inlet and air outlet must not be blocked by obstacles!
	This equipment must be connected to a ground wire.

	Note: Failure to observe the precautions may result in personal injury or equipment failure and related property losses.
	It is forbidden to store living animals, flowers or other items with strict temperature requirements in the equipment.
	When the equipment is running, do not touch the inner surface of the cabinet without wearing protective gear.
	Hold the handle and close the door to avoid pinching your fingers; When the equipment is not used for a long time, please unplug it and pack it for storage.
	When restarting the equipment after power failure or power off, please check the equipment settings first, otherwise the stored items may be damaged due to the change of settings.
	The equipment can be used for item preservation, not as production equipment!
	Keep the keys properly, so as to avoid accidents when children open the door accidentally.
	When handling the equipment, please be careful not to tip over the equipment, so as to prevent equipment damage or personal injury.
	When handling, it shall be lifted from the bottom, with the inclined plane not be greater than 45°, and it shall be handled with care. Please use the equipment in safe areas. Improper use may cause harm to human health or environment.

3. Precautions in Use

- ◆ Before putting the items into the equipment, please confirm that the temperature in the pharmacy refrigerator storage chamber has reached the set value first, and then put the articles in batches. Every time you put in items, they shall not exceed 1/3 of the inner volume of the storage chamber so as to prevent excessive temperature rise.
- ◆ The equipment temperature display value is the temperature at the temperature sensor in the storage chamber. There is a certain gap between the displayed temperature and the actual temperature at the center of the equipment when the equipment just starts running, but as the equipment enters a stable state, the displayed temperature will gradually approach the actual temperature.
- ◆ Please use a diluted neutral cleaner to clean the equipment, and do not use brushes, acid, gasoline, soap powder, polishing agent or hot water to clean the equipment, otherwise the painted surface and plastic rubber parts may be damaged. Be careful not to wipe plastic rubber parts with volatile solvents such as gasoline.
- ◆ When the equipment is not used for a long time, the power supply shall be cut off.

4. Product Installation

4.1 Installation Environment

- ✦ Ambient temperature: 16°C ~ 32°C, the most ideal temperature is 18°C ~ 25°C, and the air conditioning system shall be used when necessary.
- ✦ Relative humidity: ≤80%RH.
- ✦ There is no strong vibration and corrosive gas around.
- ✦ Avoid the existence of a large amount of dust.
- ✦ Avoid rocking or shaking the equipment.
- ✦ Elevation of the working position of the equipment: less than 2000m.
- ✦ Indoor use, pollution degree 2, and overvoltage category II.
- ✦ Input voltage AC single-phase 110V±10%,
- ✦ There is no direct sunlight, other cold and heat sources and strong electromagnetic interference, which will affect the normal operation of the control system and directly damage the system in severe cases.

4.2 Installation Site

In order to operate the equipment normally and obtain the best performance level, the installation site of the equipment shall meet the following requirements:

- ✦ It cannot be installed in a narrow and closed space, and the door of the room shall not be smaller or lower than this equipment, which shall at least ensure the normal access of the equipment, so as to avoid the maintenance difficulties in case of equipment failure, which may result in damage to stored items due to the failure to repair the equipment in time;
- ✦ The installation floor must be solid, flat, non-combustible and able to bear the weight of the equipment during operation;
- ✦ It shall be with good ventilation, and direct sunlight shall be avoided;
- ✦ Each equipment needs to use a power outlet independently. Please ensure that the current borne by the power outlet shall be ≥10A, and the plug and outlet are firmly connected;;
- ✦ Check the working voltage before use. In areas with unstable voltage, consider using a voltage stabilizer suitable for equipment load. The power of the voltage stabilizer is greater than 4KW to ensure that the input voltage requirements in the installation environment are met.
- ✦ Equipment shall be reliably grounded. If the power cord outlet is equipped with grounding wire, check whether the grounding is good before use. If the outlet is not equipped with grounding wire, it must be installed by professional engineers and technicians.

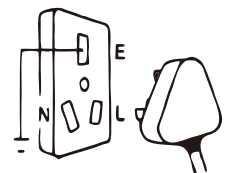

Figure: N and E ends cannot be connected



Attention: Since the ambient temperature has great influence on the equipment, if the above environmental requirements cannot be met, the equipment may not run normally. Please improve the environment before using the equipment; The equipment is operated intermittently.

4.3 Preparation before use

1. Remove the outer packaging of all products (including the protective foam in the packaging box)



Warning: Don't put the plastic bags within the reach of children, so as to prevent suffocation accidents.

2. Inventory of accessories: Please check the accessories and materials according to the packing list.

3. Cleaning: Clean the product once before use.

4. Before use remove the small wire shelf and put it at the bottom of the cabinet (applicable to SPR-55S).

5. Installation of door handles (SPR-1015S). In order to install handles, the handles shall be placed together with accessories.

Handle installation method:

Firstly, open the door handle as shown in the following figure;

Then, remove the screw for installing the door handle on the cabinet, and install the handle seat with this screw;

Finally, install the handle cover, insert both ends of the handle cover into the corresponding grooves of the handle seat, and then press it to close it.

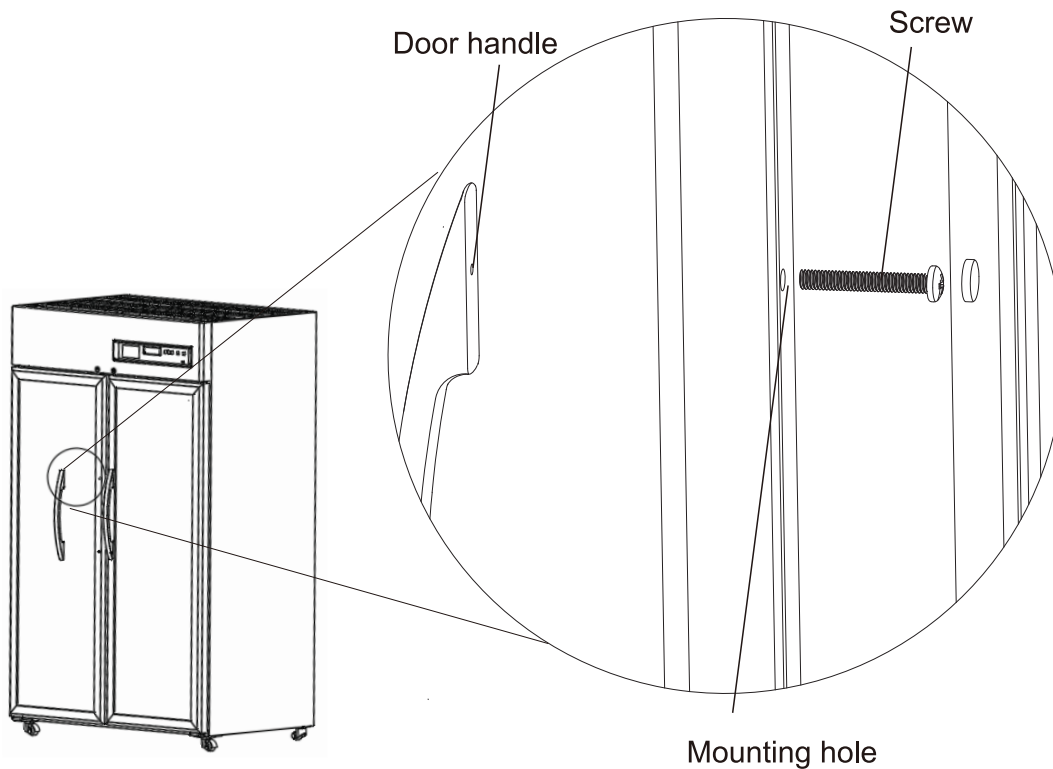

4.4 First Power-on

When using the equipment for the first time, please follow these steps:

1. After the equipment is placed, leveled and cleaned, it shall stand for more than 24 hours, and then power it on to ensure the normal operation of the equipment.
2. Under no-load condition, connect the power cord to a special outlet with appropriate specifications.
3. After powering on, turn on the power switch of the equipment.
4. Check whether the operating temperature of the equipment reaches the required value, observe the normal start and stop of the equipment for more than 24 hours, and put a small amount of items in the Refrigerator after confirming the normal performance.
5. Please store items in batches, with the items not exceeding 1/3 of the cabinet volume each time. Ensure that the equipment is running properly after shutdown for more than 12 hours before putting in the next batch of items).
6. Try not to open the door during cooling, otherwise the temperature will rise.

4.5 Operation after Power Failure

1. The equipment has a memory function for the set value. When the power is restored after power failure, the equipment will continue to operate before power failure.
2. Once the equipment is powered off, it requires 5 minutes before it can be switched on again, so as to avoid damaging the compressor.
3. We guarantee the normal operation of this equipment under certain conditions, but we are not responsible for any loss or damage of stored items after power failure.



Notes:

- ◆ The transportation and movement of equipment is realized by casters.
- ◆ A special person shall be responsible for checking and recording the running status of the equipment every day (record and check once every 2-4 hours). In case of failure or shutdown, the temperature in the Refrigerator will rise. If it cannot be repaired in a short time, please take out the stored items and transfer them to a place that meets the temperature requirements for storage to avoid damage to the items.
- ◆ Before putting items into the equipment, it shall be confirmed in advance whether the temperature range of the equipment meets the temperature requirement of the items, so as to avoid damage to stored items due to the difference between the settable temperature of the equipment and the required temperature of the items. Please pay attention not to block the air outlet and air inlet when putting items into the equipment.
- ◆ Due to the refrigeration inertia, there is a certain difference between the actual display temperature and the set temperature of the equipment, which is a normal phenomenon.
- ◆ The equipment is an item storage equipment, which cannot be used for routine production operations. It is strictly forbidden to put too many items which are relatively hot into the equipment at one time, otherwise the compressor will run for a long time, and be burned due to high temperature. Items must be put in batches, so as to ensure that the Refrigerator is cooled step by step until the temperature required for storing items is reached.
- ◆ Electrical appliances without production license shall not be used inside the equipment.
- ◆ Do not change the set temperature frequently in a short time, otherwise the expected setting effect may not be achieved due to the large temperature inertia; Ensure that there is a certain air circulation space around the cabinet when putting in items, especially do not block the temperature sensor in the cabinet (for collecting the temperature of the cabinet), otherwise it will affect the stability and accurate control of the temperature in the cabinet!
- ◆ Items shall not be placed directly at the bottom of the Refrigerator, but on the bottom shelf, otherwise the refrigeration effect of the equipment will be affected.
- ◆ When putting in items, if the moisture content of the items is too much or too little, it will affect the humidity change in the cabinet, so it is best to keep the items sealed; The humidity of the working environment will affect the change of humidity in the cabinet, especially if the door is opened too frequently and the door is not closed properly.



Warning:

- ◆ Children are not allowed to play with this equipment as a game prop, otherwise the injury or loss caused therefrom will be at their own risk.
- ◆ To avoid the risk of electric shock, this equipment must only be connected to a supply mains with protective earth.
- ◆ No modification of this equipment is allowed.
- ◆ Do not modify this equipment without authorization of the manufacturer.
- ◆ Protection impairment if used in a manner not specified by the manufacturer.
- ◆ The instructions concerning persons (including children) with reduced physical, sensory or mental capabilities, or lack of experience and knowledge and children playing with the appliance are not required.
- ◆ Keep all ventilation openings in the enclosure or, in the structure for building in, clear of obstruction.
- ◆ Do not use mechanical devices or other means to accelerate the defrosting process, other than those recommended by the manufacturer.
- ◆ Do not damage the refrigerant circuit.

5. Product composition and overview

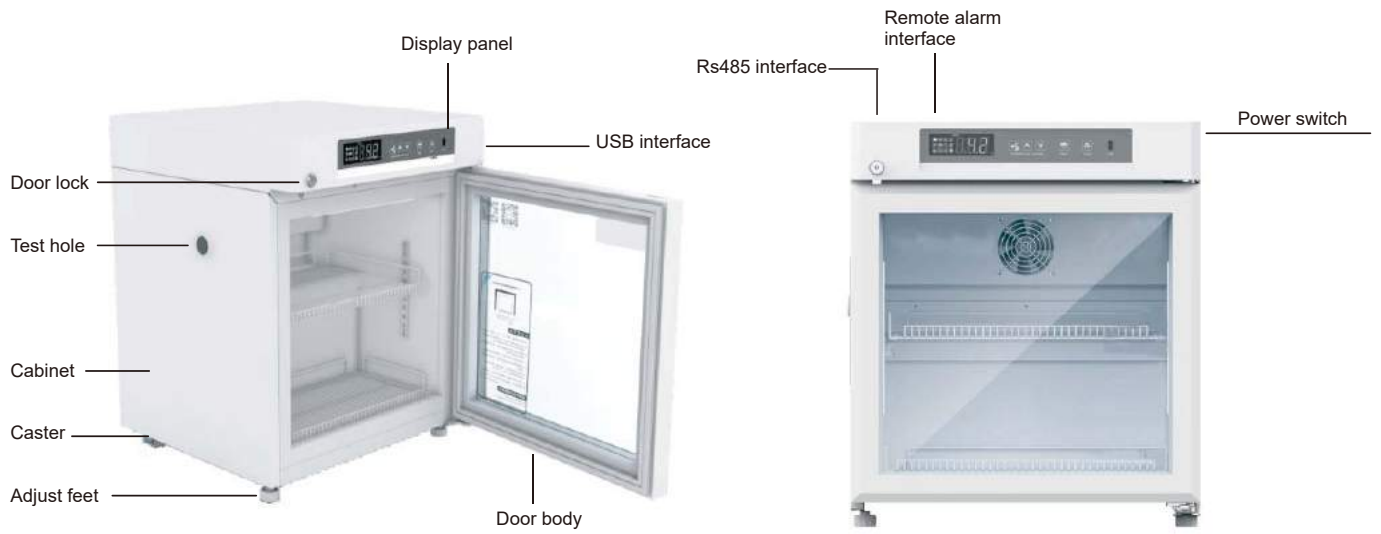

Figure I SPR-55S (It can be used as reference for SPR-55S)

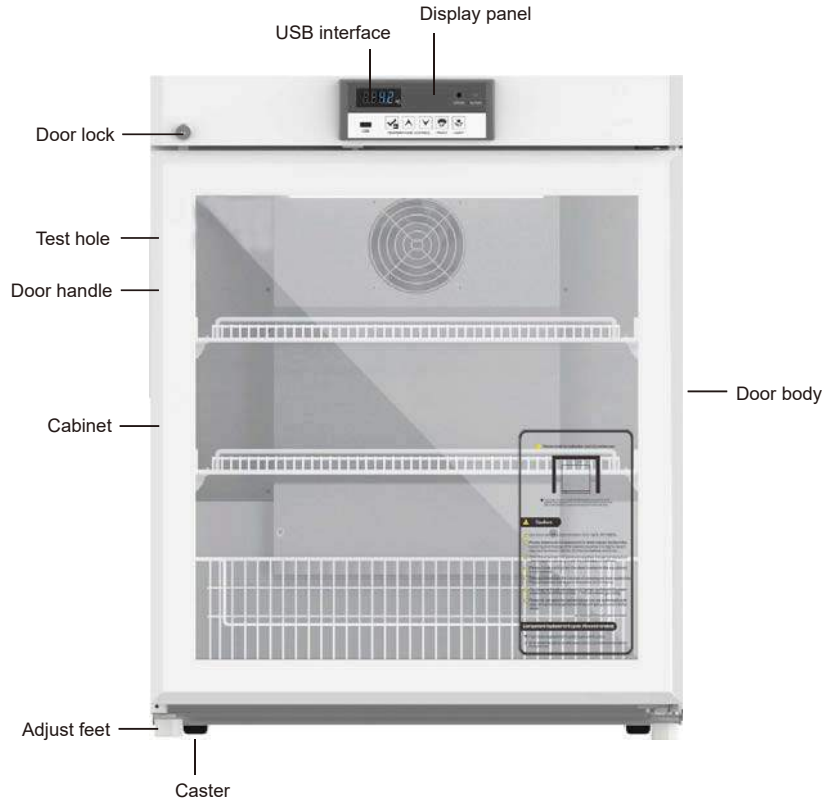

Figure II SPR-135S



Figure III SPR-315S (It can be used as reference for SPR-315S, SPR-395S and SPR-525S)

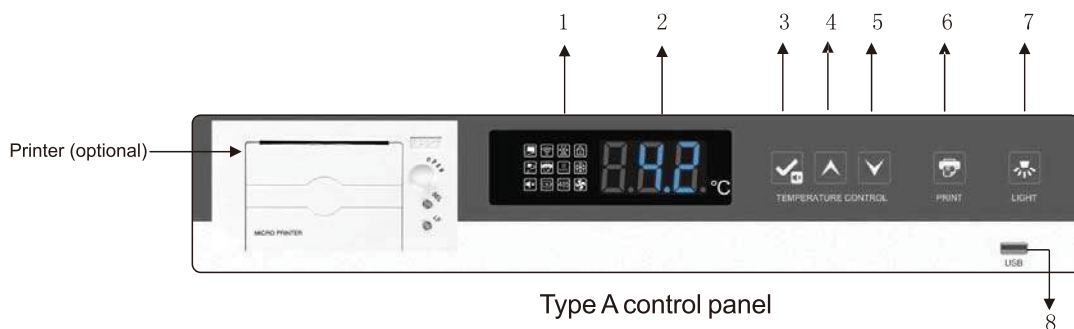

Figure IV SPR-1015S (It can be used as reference for SPR-1015S)

6. Operating Instructions

6.1 Function Introduction

This series of products include two control systems, based on which different adjustment methods apply. Please select the proper adjustment method according to the type of control system with the storage box you purchased.



1. Function description of Type A control panel (Applicable of SPR-55S, SPR-315S, SPR-395S, SPR-525S, SPR-1015S)

1) Description of display icon indicator (as shown in the right diagram)

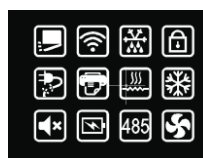

Door switch	WiFi	Defrosting	Key lock
Power failure	Print	Door heating	Refrigeration
Mute	Electric quantity	Serial port	Fan

a. Door switch indicator

When the door is opened, the door switch indicator is on; When the door is closed, the door switch indicator is off.

b. Defrosting indicator

When the refrigerator enters the defrosting state, the defrosting indicator is always on; When the refrigerator exits the defrosting state, the defrosting indicator is always off.

c. Key lock indicator

When the keys are in lock state, none of the keys respond, and the key lock lights up. In this case, after pressing the up key+down key for 3s, you will be prompted to enter the password, which is defaulted as "005." After entering it correctly, press the Set/Mute Multiplex key, and the key lock will be released. At this time, the key lock indicator will be off. In the unlock state, if no key is pressed for 60s, the key lock is started, and the key lock indicator is on. Long press the up key + down key for 3s, and the keys are locked.

d. Power-off indicator

The refrigerator is normally powered by 110V. When the input power is turned off, the buzzer will be triggered, the digital tube flashes the power-off code "PF" alternately at 3s intervals, and the power-off indicator is on. When the input power is turned on, it returns to normal, and the power-off indicator is off.

e. Print indicator

When the printer is not working, the indicator is off; When the printer is working, the indicator is on.

f. Door heating indicator

When the door heating is turned off, the door heating indicator is off; When the door heating is turned on, the door heating indicator is on.

g. Refrigeration indicator

If the compressor is in working condition, the refrigeration indicator is on; If the compressor is in a shutdown state, the cooling indicator is off.

h. Mute indicator

When the alarm tone key is muted, the indicator is on; When the alarm mute function is canceled, the indicator is off.

i. Low battery level indicator

When the battery voltage is less than 8V, the buzzer will be triggered, the low battery indicator will be on, and the digital tube will flash the low battery code "BL" alternately at intervals of 3s; When the battery voltage is greater than 12V, the buzzer will be turned off, the low battery indicator will be off, and the digital tube will resume normal display.

j. Serial port indicator





When the reserved RS-485 serial port is not connected to the equipment, the serial port indicator will be off; When the equipment is successfully connected to the reserved RS-485 serial port, the serial port indicator will be on.





k. Fan indicator



When the evaporator fan is turned on, the fan indicator is on; when the evaporator fan is turned off, the fan indicator is off.



2)  temperature display window, which displays the average temperature inside the cabinet in °C under normal operation;

View ambient temperature:

In the key lock state, press  key, and digital tube displays the ambient temperature, and returns to normal display after 5 s without key operation, or pressing  and . In the key unlock state, press  key, and digital tube displays ambient temperature, and returns to normal display after 5s without key operation.

Humidity check: key unlocked state, long press  and , digital tube display humidity, no press any Key operation after 5 seconds or press  and , return to normal display.

3)  is the set/mute key; In case of no alarm state and key unlock state, press , and display the ambient temperature for 5s and then return to normal display; In the unlock state, press  for more than 3s, and enter the user menu.

When buzzer is triggered (including cabinet high temperature alarm, door opening alarm, sensor failure alarm, etc.) and in the key unlock state, press  for the first time, and the buzzer stops ringing, and the ambient temperature is displayed for 5s, after which the normal display is resumed (pressing the mute button is only to turn off the buzzer for alarming this abnormal state, for example troubleshooting, and the buzzer will be triggered next time for any abnormality). Then press  again, trigger the buzzer, display the ambient temperature for 5s, and resume the display of chamber temperature and alarm state. In the key unlock state,  can be used as a setting key.

In unlock state and parameter setting mode, press this key to display parameter values and parameter names. If the pressing time is longer than 3 seconds, save the settings and return to the normal interface.

4)  is a up key; In parameter setting mode, move to the next parameter or increase the parameter value. For example, when setting the set temperature, increase the set temperature value. When setting the parameter value, long press the up button, and the parameter will increase rapidly. Under normal conditions, long press the up key for 3 seconds to import the data of the USB flash drive in 12 months.

5)  is a down key;

In parameter setting mode, move to the previous parameter or decrease the parameter value.

For example, when setting the set temperature, reduce the set temperature.

When setting the parameter value, long press the down button, and the parameter will decrease rapidly.

6)  is a print key;

The system can keep 7 days of data for printing, and press the print key to print the temperature within the set time period.

7)  is a light switch key;

When the equipment is powered on, the lights are turned off by default. Press the light switch key to turn the lights on and off. When the light is off, it can be turned on when the door is opened and turned off when the door is closed; When the light is off, it does not change when the door is opened or closed. This equipment has two functions: automatic lighting and manual lighting. In the automatic lighting state, the lighting lamp will be on immediately when the door is opened, and the lighting lamp will be off after a 5 seconds delay; The user can also turn on the lighting lamp manually. In this case, the lighting lamp is always on (the indicator light above the key is on) without being controlled by the door opening and closing. Only when the manual lighting is turned off by pressing the light switch key again can the lighting lamp be automatically on (the indicator light above the key is off).

8) USB data export;

Automatic export: When the USB interface is connected to the USB flash drive, the buzzer of the recorder beeps once, displaying "on," and PDF files of the data of the current month and the previous month are generated in the USB flash drive. After the data transmission is completed, the buzzer beeps once, displaying "End," and the normal display resumes after 6s.



Note: When there is less data, the digital tube will not display "on" and "End."。

Manual export: In the key unlock state, and when the USB flash drive is connected and the file is not being generated, press the key up for 3 seconds, and the digital tube will display "d01." Press the up key or down key to adjust "d00~d12," and press  key to obtain the file generation (d00) or generate the PDF file of the record data of the previous months (1-12).

2. Function setting of Type A control panel



1. After powering on, the equipment can enter the working state;

2. User parameter settings:



To unlock: under normal operating conditions,  and  long press for 3 seconds, the digital display code "000", input password "005" to unlock (enter "099" can restore the default user password to "005" again if user forget the password). After unlock,  hold for 3 seconds, it will enter user menu. If the controller displays "PS1", it means enter user menu successfully.

Use  or  key to scroll the parameters, and the display order is as follows:

Ps1→b1→b2→Set→H→L→n→y→r→S→F→Pt→tH1→P1→P2. Press  to confirm the parameter type, and the first parameter name of this type of parameter will be displayed;

① Use  or  key to scroll the parameters;

② Press  key to display the corresponding parameter value;

③ Use  or  key to scroll the parameters;

④ Use  to temporarily store the modified values and return to the display parameters;

⑤ If other parameters are modified, repeat steps ① to ④;

⑥ Press  for more than 3s, save the modified parameters and return to the display parameter category.

3. Press  for more than 3s, or press no key in 60s to exit the parameter setting program.

4. Parameter display

No.	Menu item	Parameter Range	Suggested settings	Remarks
1	Set	0.0-10.0	5.0	Temperature setting
2	H	0.0-10.0	5.0	Set value of high temperature alarm set+H; When H =0, High temp alarm is disabled; When the alarm is over high temp alarm set, H1 will be displayed on the controller
3	L	0.0-10.0	4.0	Set value of low temperature alarm set-L; When L =0, Low temp alarm is disabled; When the alarm is below low temp alarm set, L1 will be displayed on the controller
4	Pt	0-240 min	20	Print interval
5	tH1	20.0-50.0°C	50	Upper limit of ambient temperature alarm
6	P1	1. Automatic heating mode 1 2. Automatic heating mode 2 3. Automatic heating mode 3 4. Always on 5. Always off	1.(Set to 4 when the door is with condensation) (Set to 1 when the door is a glass door) (Set to 5 when the door is a foaming door)	Mode 1: It shall be judged as once after the door is opened and closed once and heated for 5min (time setting). If the door is opened and closed again during the heating period, the heating time will be updated again; Mode 2: When the compressor runs, Heater is on; When the compressor stops, the heater Will automatically off after one min Mode 3: When the humidity in the cabinet is more than 80%, the door heating is on, and when the humidity in the cabinet is moderately less than 60%, the door heating is off; Mode 4: Door heating is always on; Mode 5: Door heating is always off.
7	P2	1.Average temperature 2.Upper temperature 3.Lower temperature	1	Display mode selection (optional function)
8	PS1		005	User menu password settings

No.	Menu item	Parameter Range	Suggested settings	Remarks
9	MAX	—	—	The highest temperature since last clearance
10	MIN	—	—	The lowest temperature since last clearance
11	CLR	—	—	Clearance of the Max and Min temperature records

5. Alarm display

Alarm Code	Error Description
H1	High temperature alarm
L1	Low temperature alarm
H2	Alarm for high ambient temperature
H3	Condenser overheat alarm
do	Door opening alarm
PF	Power failure alarm
bL	Battery low alarm
Er	The recorder is not connected
LoF	Recorder did not start
EE	Communication failure

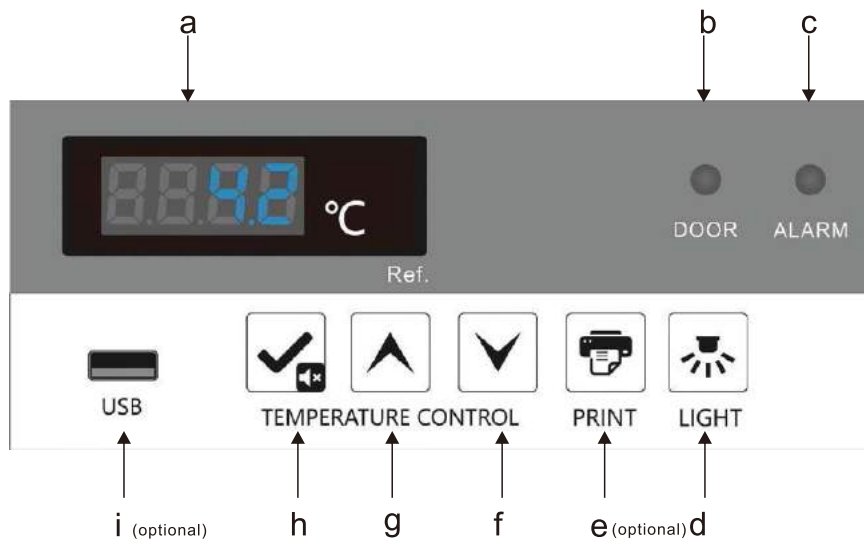

Type B control panel

1. Function description of Type B control panel (Applicable to MPR-130)

- a. 4.2 It is temperature display window, which displays the average temperature inside the cabinet in °C under normal operation; Different prompt characters can be displayed in the setting state (see below for details);
- b. Door opening indicator: When the refrigerator door is opened, the indicator lights up. After more than 1 minute, the door opening alarm indicator will be on and the buzzer triggered, displaying "do".
- c. Fault indicator: When the product runs normally, the indicator is off; The indicator is on for operation abnormality.
- d. "LIGHT" : After the machine is powered on, the light is off by default, and the on-off of the light can be adjusted by the on-off key. When the light is off, it can be turned on when the door is opened and turned off when the door is closed; When the light is off, it does not change when the door is opened or closed. This equipment has two functions: automatic lighting and manual lighting. In the automatic lighting state, the lighting lamp will be on immediately when the door is opened, and the lighting lamp will be off after a 5 seconds delay; The user can also turn on the lighting lamp manually. In this case, the lighting lamp is always on (the indicator light above the key is on) without being controlled by the door opening and closing. Only when the manual lighting is turned off by pressing the light switch key again can the lighting lamp be automatically on (the indicator light above the key is off).
- e. "PRINT " (optional): The system can keep 7 days of data for printing. Press the print key to print the temperature within the set time period.
- f. : In parameter setting mode, reduce the parameter value. For example, when setting the set temperature, reduce the set temperature. When setting the parameter value, long press the down button, and the parameter will decrease rapidly.
- g. : In parameter setting mode, increase the parameter value. For example, when setting the set temperature, increase the set temperature value. When setting the parameter value, long press the up button, and the parameter will increase rapidly. Under normal conditions, long press the up key for 3 seconds to import the data of the USB flash drive in 12 months.
- h. is the set/mute key; In case of no alarm state and key unlock state, press , and display the ambient temperature for 5s and then return to normal display; In the unlock state, press for more than 3s, and enter the user menu.
- When buzzer is triggered (including cabinet high alarm, door opening alarm, sensor failure alarm, etc.) and in the button unlock state, press for the first time, and the buzzer stops ringing, and the ambient temperature is displayed for 5s, after which the normal display is resumed (pressing the mute button is only to turn off the buzzer for alarming this abnormal state, for example trouble removal, and the buzzer will be triggered next time for any abnormality). Then press again, trigger the buzzer, display the ambient temperature for 5s, and then resume the display of cabinet temperature and alarm state. In the key unlock state, can be used as a setting key.

In unlock state and parameter setting mode, press this key to display parameter values and parameter names. If the pressing time is longer than 3 seconds, save the settings and return to the normal interface.

I. USB interface

Automatic export of USB data: When the USB interface is connected to the USB flash drive, the buzzer of the recorder beeps once, displaying "ON", and PDF files of the data of the current month and the previous month are generated in the USB flash drive. After the data transmission is completed, the buzzer beeps once, displaying "End," and the normal display resumes after 6s.

! **Note:** When there is less data, "on" and "end" prompts are not displayed.

Manual export of USB data: In the key unlock state, when the USB flash drive is connected and the file is not being generated, press the up key for 3 seconds, and the digital tube in the lower chamber will display "d01." Press the key up or down key to adjust "d00~d12," and press  key to cancel the file generation (d00) or generate the PDF file of the record data of the previous months (1-12).



! **Note:** When the alarm of the digital tube flashes and displays "LoF," the recorder is not started;



Meanwhile press  and  key for 3s, and "LoF" disappears, the recorder is started.

2. Function setting of Type B control panel



1) Power on and turn on the power switch on the back of the cabinet, and the equipment will enter the working state;

2) User parameter settings:



Unlock: In normal operation state, simultaneously press  and  key for 3s, and the digital tube displays the parameter code "000", enter the password "0005" (when you enter the user menu password, enter "0099" to restore the key lock password to the default value of "0005"). , and unlock it. Unlock and press  key for 3s, and the digital tube will display the parameter code "PS1," and enter the setting and adjustment parameters.

Use  or  key to scroll the parameters, and the display order is as follows: b1→b2→Set→H→L→n→y→r→S→F→Pt→tH1→P1→Ps1.

Press  to confirm the parameter type, and the first parameter name of this type of parameter will be displayed;

① Use  or  key to scroll the parameters;

② Press  key to display the corresponding parameter value;

③ Use  or  to increase or decrease the value ⑥; Press  for more than 3s, save the modified parameters and return to the display parameter category.

④ Use  to temporarily store the modified values and return to the display parameters;

⑤ If other parameters are modified, repeat steps ① to ④.

4. Parameter display

No.	Menu item	Parameter Range	Suggested settings	Remarks
1	MAX	—	—	The highest temperature since last clearance
2	MIN	—	—	The lowest temperature since last clearance
3	CLR	—	—	Clearance of the Max and Min temperature records
4	b1	—	—	Hardware version
5	b2	—	—	Software version
6	Set	0.0-10.0	5.0	Temperature setting
7	H	0.0-10.0	5.0	Set value of high temperature alarm set+H; When H =0, High temp alarm is disabled; When the alarm is over high temp alarm set, H1 will be displayed on the controller
8	L	0.0-10.0	5.0	Set value of low temperature alarm set-L; When L =0, Low temp alarm is disabled; When the alarm is below low temp alarm set, L1 will be displayed on the controller
9	Pt	0-240 min	20	Print interval
10	tH1	20.0-50.0°C	40.0	Upper limit of ambient temperature alarm
11	P1	<p>1. Automatic heating mode 1</p> <p>2. Automatic heating mode 2</p> <p>3. Automatic heating mode 3</p> <p>4. Always on</p> <p>5. Always off</p>	<p>1. (Set to 4 when the door is with condensation) (Set to 1 when the door is a glass door)</p> <p>(Set to 5 when the door is a foaming door)</p>	<p>Mode 1: It shall be judged as once after the door is opened and closed once and heated for 5min (time setting). If the door is opened and closed again during the heating period, the heating time will be updated again;</p> <p>Mode 2: When the compressor runs, Heater is on;; When the compressor stops, the heater Will automatically off after one min</p> <p>Mode 3: When the humidity in the cabinet is more than 80%, the door heating is on, and when the humidity in the cabinet is moderately less than 60%, the door heating is off;</p> <p>Mode 4: Door heating is always on;</p> <p>Mode 5: Door heating is always off.</p>
12	PS1	0000-9999	0005	User menu password settings

5. Alarm display

Alarm Code	Error Description
H1	High temperature alarm
L1	Low temperature alarm
H2	Alarm for high ambient temperature
H3	Condenser overheat alarm
do	Door opening alarm
PF	Power failure alarm
bL	Battery low alarm
Er	The recorder is not connected
LoF	Recorder did not start
EE	Communication failure

6.2 Optional function

1. Printer

Automatic printing:

When the printing interval P_t is not 0, the printer prints the current data every P_t minutes.

Manual printing:

When the key is unlocked and the working voltage is normal, press the print key to display "P01" by the digital tube, press the up key or down key to adjust "P00~P07." Press the set/mute multiplexing key or print key, and the printer will cancel the manual printing (P00) or print the data recorded in the previous days (1 ~ 7), with the data interval same as the automatic printing interval.

Printing paper installation:

The printing paper has been installed at the factory. When the paper is used up after a long time, you may purchase the same paper for installation. The installation steps are as follows:

- ① Click the cylindrical button on the printer to open the cover of the printer;
- ② Put the printing paper into the printer box and pull the paper head of the roll so that the paper slightly exposes from the upper port of the box cover after the box cover of the printer is closed;
- ③ Close the box cover.

2. Remote alarm terminal and RS485 interface

The remote alarm terminal is installed on the back of the cabinet, and the alarm signal is output by the terminal. The load-bearing capacity of the terminal is 30V, 2A DC. Users can choose normally open, normally closed and common terminals according to their own needs.

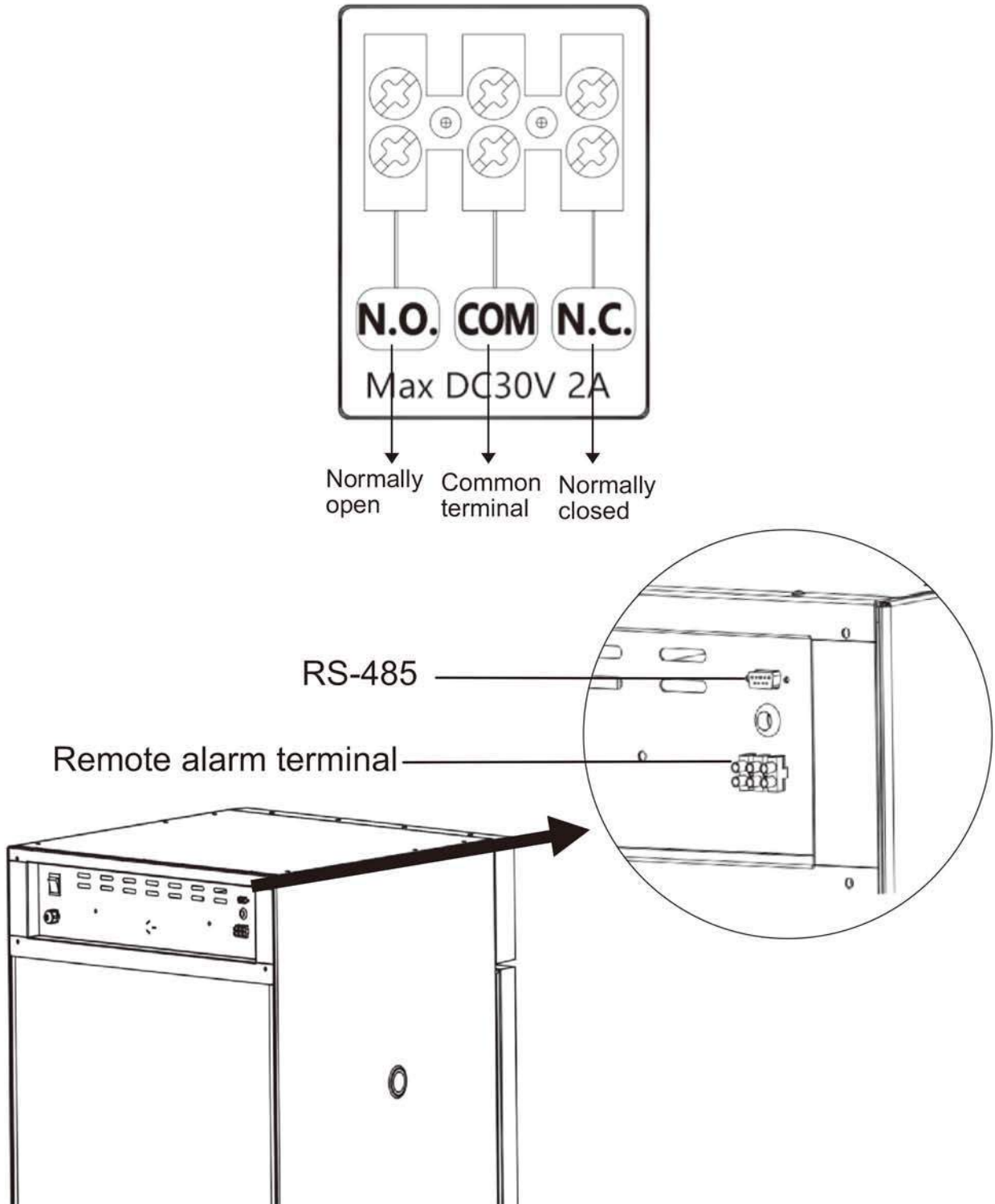

7. Maintenance and Service



Warning:

- ◆ In order to prevent people from getting electric shock or injury, please cut off the power supply of the equipment before any repairs and maintenance
- ◆ Make sure you don't inhale drugs or suspended particles around it when maintaining the equipment, otherwise it will harm your health

7.1 Equipment Maintenance

Defrosting: The equipment will automatically defrost during the working process for the convenience of use.

Cleaning and maintenance: The equipment should be cleaned and maintained regularly (for safety, please unplug the power plug), and the inner and outer surfaces of the cabinet should be wiped with a warm, damp soft cloth.



Notes:

- ◆ Do not sprinkle water directly on the cabinet, lest the insulation performance of electrical components decrease and metal parts rust.
- ◆ Do not use hot water, corrosive detergent or organic solvent to clean the cabinet
- ◆ Do not place heavy objects on top of the equipment, as the equipment may deform under pressure.

7.2 Equipment Discontinuation

Deactivation: If the equipment is stored in an unsupervised area for a long time and not used, the power supply should be cut off and the inner and outer surfaces of the cabinet should be cleaned with a warm, damp soft cloth, aired and sealed. The equipment must be locked to ensure that children cannot open the cabinet door.

Scrapping: When the equipment reaches the end of its service life, it should be scrapped and must be handed over to a qualified professional recycling agency for disposal per local regulations. Non-professionals are not allowed to disassemble and break down the equipment without authorization. The scrapped equipment should be placed in a designated area inaccessible to children to avoid danger.

7.3 Maintenance, Replacement, and Recovery of Rechargeable Batteries

Battery installation position: top of the cabinet and bottom inside the electrical box.

1. Battery maintenance

- ① In order to prolong the service life of the battery and avoid the product being left unused for a long time, the product must be operated for more than 24 hours every month to facilitate charging.
- ② When the equipment is not used for a long time, it should be connected to the working power regularly (generally once a month), and the power lock switch should be turned on so that the equipment can run for a period of time to complete charging, and each charging time should be no less than 24 hours;
- ③ When the working power supply is interrupted, the power lock switch of the equipment shall be turned off in time, otherwise it will cause power loss in battery and even permanent damage to the battery in severe cases;
- ④ The main power switch must be turned off during a long-term power outage or during transportation, otherwise long-term discharge causes power loss in battery and even permanent damage to the battery, and the display is abnormal after re-energizing;
- ⑤ The battery is a consumable, with a service life of about 2-3 years. If the battery is used improperly, such as power loss or reaching the end of battery life, it will cause a low battery alarm (refrigeration is not affected, but there is an alarm failure and influence to the use function of the printer, please contact the after-sales staff of local distributors for replacement).

2. Battery replacement and recovery

- ① Turn off the power switch and pull out the power plug from the outlet;
- ② Remove the screws on the electrical box with a screwdriver. (Note: There are high-voltage electrical components in the electrical box, therefore before opening, turn off the power supply, unplug the power plug and turn off the power lock switch of the refrigerator, and the electrical box can only be opened by qualified engineers or maintenance personnel).
- ③ Pull out the battery connecting cable; (Before unplugging the battery fixing cable, pay attention to the cathode/anode of the battery and the sequence of the connecting cables, so as to prevent burning down the control system due to installation of the new battery with cathode/anode reversed. Generally, the red wire is connected to the cathode, and the black wire is connected to the anode.
- ④ Use a screwdriver to remove the fastening screws on the battery fixing plate and take out the battery;
- ⑥ For a replaced battery that can be recycled, please contact local battery recycling agency.

re

Tips: In order to effectively ensure that the battery replacement meets the requirements of the control system and avoid the influence of improper operation on the system, please contact our after-sales personnel for replacement or guidance.

8. Troubleshooting and Maintenance Services

Any product may fail. Please observe the operation of equipment in time during use. If there is any abnormality, please check and handle it according to the following table first. If the abnormality can't be changed, please inform our service center in time, and we will serve you wholeheartedly to avoid losses.

Fan motor replacement time: about 6 years; Service life of the product: 10 years.

Problems	Causes and solutions
Equipment does not work	Please make sure that the outlet is energized. Please make sure power plug is plugged in, not loose. Please make sure the power fuse is not disconnected. Please make sure the supply voltage is appropriate, not too low or too high.
Compressor is not running	Please make sure that the temperature is set correctly. Please check whether the temperature inside the cabinet is too low.
The temperature does not reach the set value	Please make sure that the door is closed tightly and don't open it too many times during a short time. Please don't put too many items in at one time. Please make sure that the ambient temperature is not too high.
High noise	Please make sure that the cabinet is placed on a flat ground. Please make sure that the cabinet does not contact the wall.
Condensation on cabinet surface	In rainy and humid seasons, door condensation is normal, and it shall be wiped off with a dry cloth.
Undesirable odor	Equipment needs to be cleaned. Items with heavy smell are not packed.
The door is not closed properly, and the cool air leaks	Please make sure that the temperature is set correctly. Please check whether the temperature inside the cabinet is too low.
The alarm lamp flashes and the buzzer is triggered	After the equipment is used for a period of time, the door seal becomes hard and deformed. Maintenance method: Blow the deformed part of the hot seal with a blower to soften it, and then close and compress it after the door seal becomes soft.
Lighting damage (refrigeration equipment)	Please call the after-sales telephone and contact after-sales service personnel of Stalwart for replacement. Please do not replace the parts by yourself.

The following conditions are not faults

- ① When the compressor starts and stops, the equipment parts will make a slight impact sound;
- ② When overheated items are put in after the door is opened, high temperature alarm and high humidity alarm will be triggered in the control system (if this function is available, please refer to the alarm display table);

Solution: Put the items into the equipment after they are naturally cooled. Put the items in small quantities in batches, and do not put too much at a time. After the system runs stably, the high temperature alarm and high humidity alarm will be released automatically.

- ③ Slight sound of running water caused by refrigerant flowing in the pipeline.



Warning:

- ◆ The system contains refrigerant under high pressure. Do not tamper with the system. It must be serviced by suitably qualified persons only.
- ◆ Connect to potable water supply only.
- ◆ Do not store explosive substances such as aerosol cans with a flammable propellant in this appliance.
- ◆ If symbol ISO 7000-1701 (2004-01) is used, its meaning shall be explained.
- ◆ In order to reduce flammability hazards the installation of this appliance must only be carried out by a suitably qualified person.
- ◆ The refrigeration system is under high pressure. Do not tamper with it. Contact qualified service personal before disposal.

Notes:

- ◆ The equipment can only be repaired, maintained or improved by the engineers certified by Stalwart so as to ensure the normal operation of the equipment and the compliance with corresponding safety standards.
- ◆ Please clean and disinfect the equipment before notifying the maintenance engineer; During the warranty period of the equipment, the Company will not undertake the warranty obligation if the fault or damage is caused by improper use of the user.
- ◆ Ambient temperature for storage: -40°C-+55°C, relative humidity: 10% ~ 90%.

9. Specifications

Model	Ambient temperature	Climate type	Rated voltage (v~)	Temp Range (°C)	Effective volume (L)
SPR-55S	16 ~32°C	N	110/60	2~8 °C	55
SPR-135S	16 ~32°C	N	110/60	2~8 °C	130
SPR-315S	16 ~32°C	N	110/60	2~8 °C	315
SPR-395S	16 ~32°C	N	110/60	2~8 °C	395
SPR-525S	16 ~32°C	N	110/60	2~8 °C	525
SPR-1015S	16 ~32°C	N	110/60	2~8 °C	1015

* The foaming material of this product is cyclopentane.

10. Packing List

Item	Operation Manual	Certificate of Conformity	Accessory package	Key
Quantity	1	1	1	2

* The door handle accessory applies to: models SPR-1015S *
 Keys apply to: models SPR-55S, SPR-135S, SPR-315S, SPR-395S, SPR-525S;
 * The specific packing list shall be subject to the physical objects received.

11. Electrical Schematic Diagram

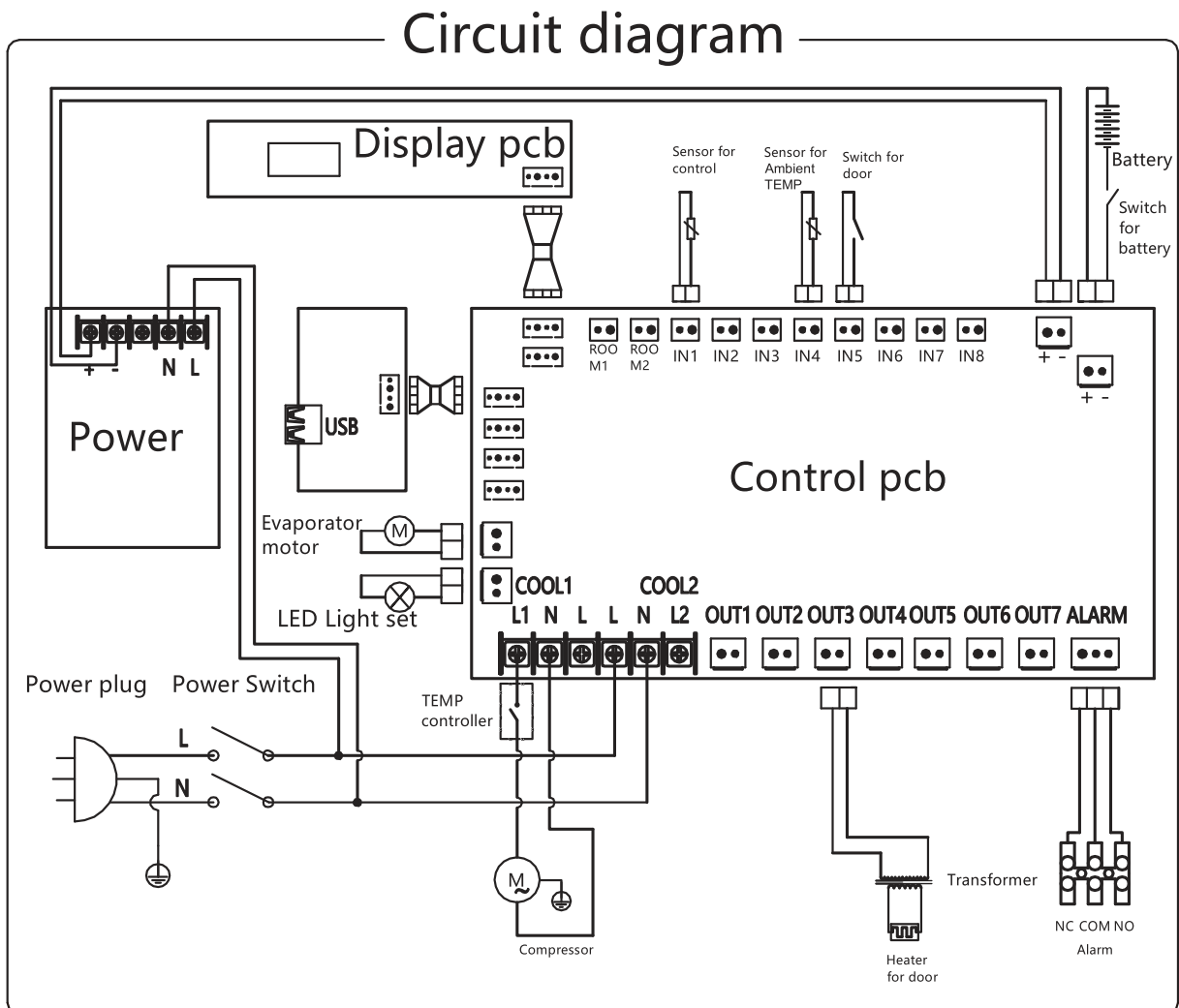

Applicable to SPR-55S

Circuit diagram

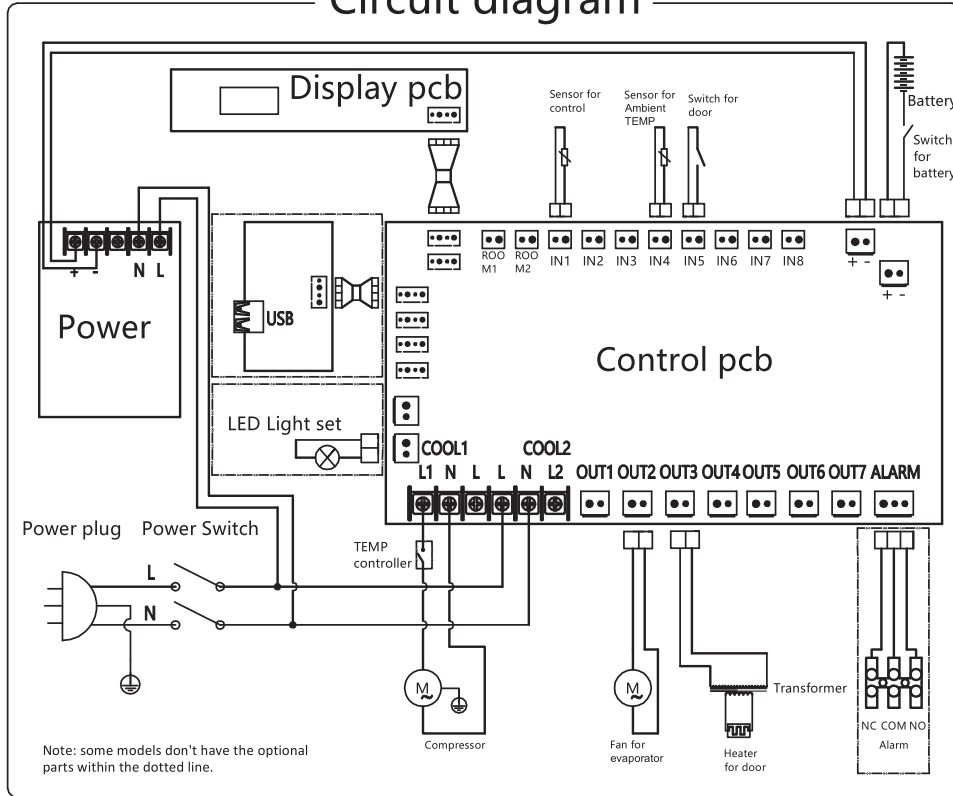

Applicable to SPR-135S

Circuit diagram

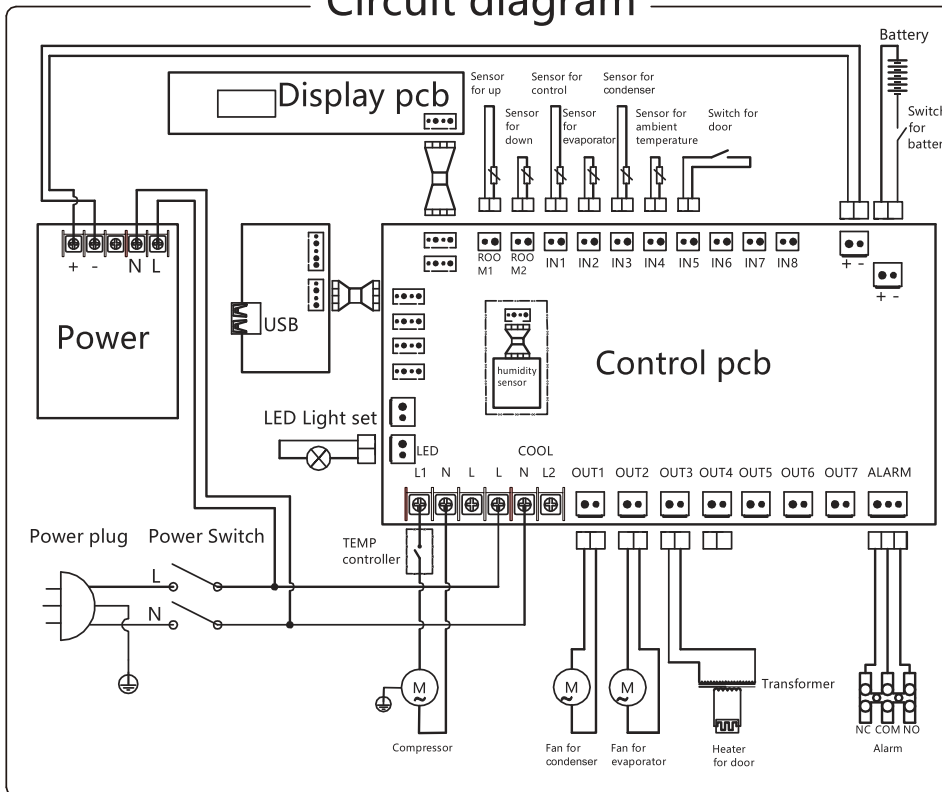

Applicable to SPR-315S/SPR-395S/SPR-525S

Circuit diagram

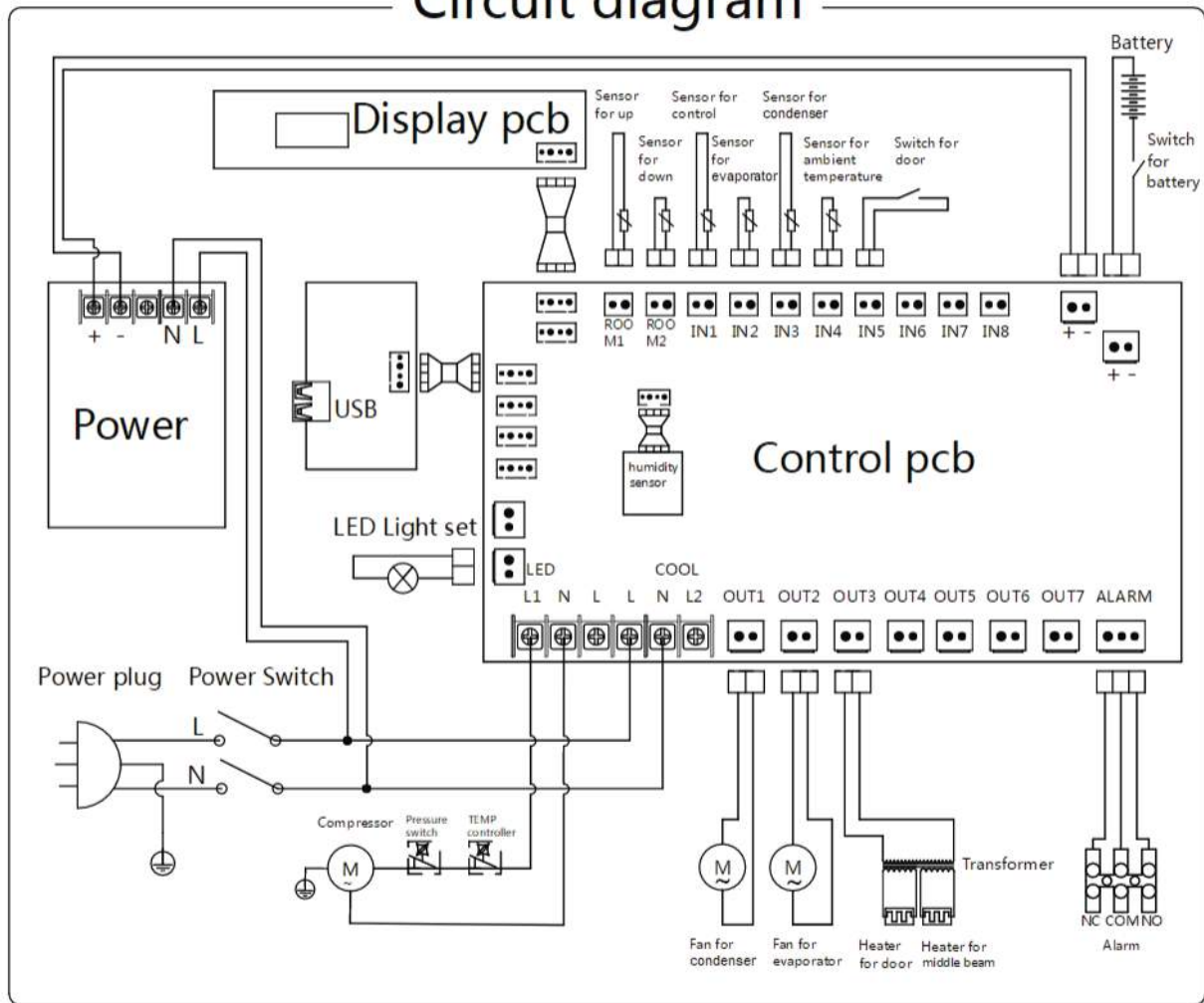

Applicable to SPR-1015

* The technical data and electrical schematic diagram shall be subject to the nameplate on the product and the electrical schematic diagram in case of any improvement of the product design. We sincerely apologize for any inconvenience that might be caused