

STALWART

Operations Manual

Version 1.0

SIS-60+ Incubator Shaker

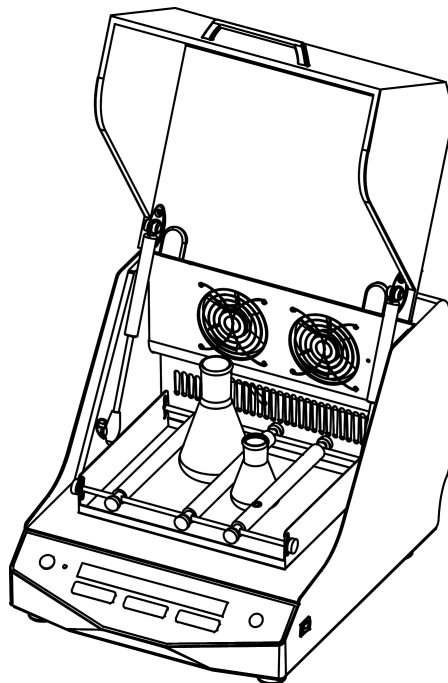

PREFACE

Thanks for choosing incubator Shaker. This operation manual describes function and operation of the instrument. In order to use the instrument properly, please read this manual carefully before operating the Instrument.

Opening Check

Please check the instrument and appendix with the packing list when you first open the packing case. If anything does not match with the packing list, please contact with the vendor or the producer.

Safety Warnings and Guidelines

1 Important operation information of the security

Users should have an entire conception of how to use the instrument properly before operating it. Please read this operation manual carefully before using the instrument.



It is forbidden operating before read the operation manual. Read the guidelines and directions below and carry out the countermeasure according to them.

2 Security

The operation, maintenance and repair of the Instrument should comply with the basic guidelines and the remarked warning below. Otherwise, it will affect the scheduled using life of the Instrument and the protection provided.



This product is a normal and an indoor Instrument which conforms to Standard B style- I type- GB9706.1.



Before operation, read the manual carefully. These units are designed for using in the laboratory environments by who're knowledgeable in safe laboratory practices.



The operator should not open or repair the instrument by himself. Otherwise, the instrument will lose the qualification of repair guarantee or cause accidents. The company will repair the instrument based on warranty description.



A.C. power's grounding should be reliable to safeguard against an electric shock. The 3-pin plug supplied with thermo-shaker's power cable is a safety device that should be matched with a suitable grounded socket.



The instrument should be put in the place where of low temperature, little dust, no water, no sunshine or hard light, and of good aeration, no corrosively gas or strong disturbing magnetic field, and far away from central heating, camp stove and other hot resource. Do not put the instrument in wet and dusty place. The vent on the instrument is designed for aeration. Do not wall up or cover the vent. The distance between each device should be more than 100cm when there is more than one instrument.



Power off when operation finished. If do not use the instrument for a long period, pull off the connector plug, cover a piece of cloth on the instrument to prevent from dust.



Pull the connector plug from the jack at once in the following case, and contact the vendor.

- There is some liquid flowing into the instrument;
- Drenched or fire burned;
- Abnormal operation: such as abnormal sound or smell;
- Instrument dropping or outer shell damaged;
- The function has obviously changed.

3 Instruments Maintenance

The instrument and the accessories should be cleaned by cloth drenched with alcohol. If there are smutches on the instrument, clean them with cloth.

4 After Service

1) Warranty Description

Within one month of delivery, the company is responsible of exchange for breakdown caused by material or manufacture.

Within 12 months of delivery, the company is responsible of free repair for breakdown caused by material or manufacture. Proven with defect under warranty, the company will exchange the instrument or free repair it alternatively.

Instrument under warranty period should be delivered to the appointed maintenance department by user. Freight from user to maintenance department will be borne by user. Freight for instrument resent to user will be borne by the company.

Repair out of warranty will be charged reasonable cost.

2) Warranty Coverage

Breakdown due to improper use, operation in inappropriate conditions, maintain or refitting without authorization are not in warranty coverage.

CONTENTS

CHAPTER 1 INTRODUCTION	1
CHAPTER 2 SPECIFICATIONS	2
1. THE NORMAL OPERATION CONDITION.....	2
2. THE BASIC PARAMETERS AND SPECIFICATIONS.....	2
CHAPTER 3 PREPARATION	3
1. STRUCTURE DESCRIPTION.....	3
2. KEYBOARD AND DISPLAY PANEL.....	4
3. DESCRIPTION OF OPERATION BUTTONS.....	4
4. POWER CONNECTION.....	4
5. EQUIPPED PLATFORM (SPW-260).....	
CHAPTER 4 OPERATION GUIDE	6
1. SPEED, TIME AND TEMPERATURE SETTING.....	6
2. START / STOP.....	7
CHAPTER 5 FAILURE ANALYSIS AND TROUBLE SHOOTING	8
APPENDIX A: WIRING DIAGRAM OF INCUBATOR SHAKER	9

Chapter 1 Introduction

The incubator shaker is one temperature controlled biochemical instrument combined incubation and shaking function. It is widely used in cell culture, fermentation, hybridization, biochemistry, research of enzyme and cell tissue, etc. which required higher quality of temperature controlling and shaking speed. It can dynamically and statically cultivate microbial cell and all kinds of strains.

Feature

1. Integrate incubator and shaker. Save laboratory space.
2. Rational and compact designed, good temperature uniformity, low noisy.
3. Micro-processor controls temperature and shaking speed. Timing function built in.
4. Design of Human-machine interface and operation panel. Cover can be wide-angle opened, convenient to watch and fetch the sample.
5. Built-in cover switch. When the cover is open, air circulation, heating and shaking will automatically stop. No temperature overshoot problem.
6. Unique speed control circuit to ensure shaker smooth starting and avoid liquid spilling.
7. Speed of the circulation fan is adjustable to avoid high-speed of the circulation fan making the sample volatilizing.
8. Independent temperature alarm system. Heating is cut off when temperature over the limited value.
9. Alarm when program completes.
10. Brushless DC motor, long life and maintenance free.

Chapter 2 Specifications

1. The Normal Operation Condition

Ambient Temperature: 4°C ~ 45°C
 Relative Humidity: ≤70%
 Power: AC110/220V~

2. The Basic Parameters and Specifications

Type	SIS-60+
Temperature Control Range	R.T. +5 ~60°C
Temperature Display Accuracy	0.1°C
Temperature Control Accuracy@37°C	≤ ±0.3°C
Timing Range	0 ~99h59min
Shaking Speed	50 ~300 rpm
Orbit	20mm (horizontal)
Power Supply	AC110V/220V 600W
Dimension	514x660x430mm
Platform	standard platform SPW-260 (410x420x65mm)

Chapter 3 Preparation

This chapter mainly describes the instrument's mechanical structure, the keyboard and functions of each key, as well as preparations before power on. Please learn this chapter well before the orbital shaker is to be operated at the first time.

1. Structure Description

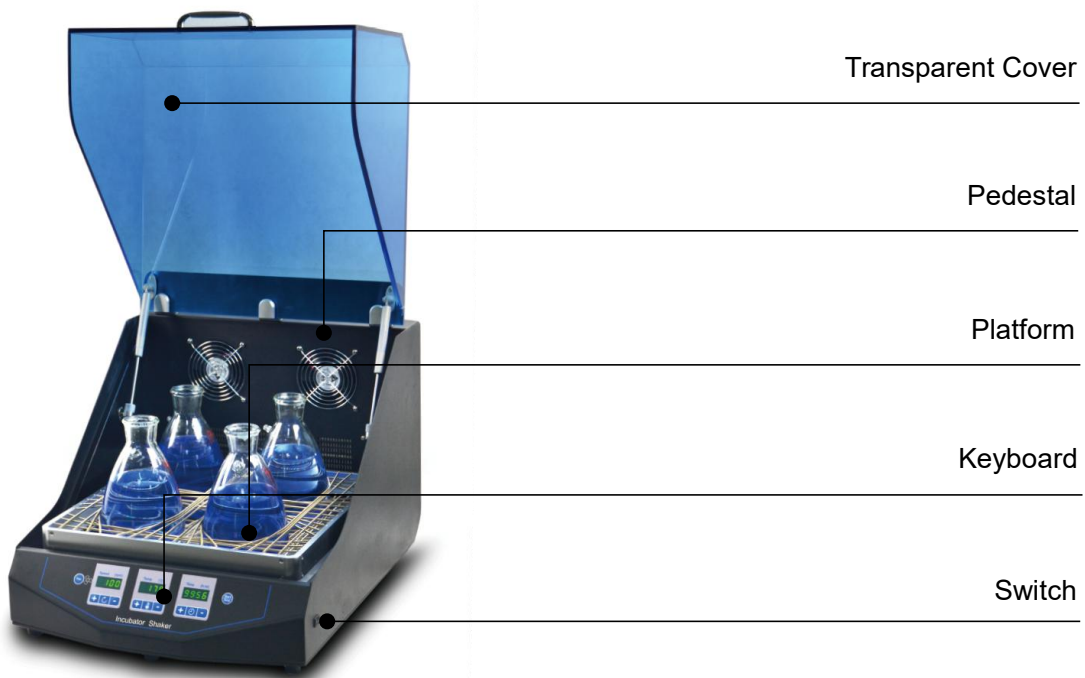

2. Keyboard and Display Panel

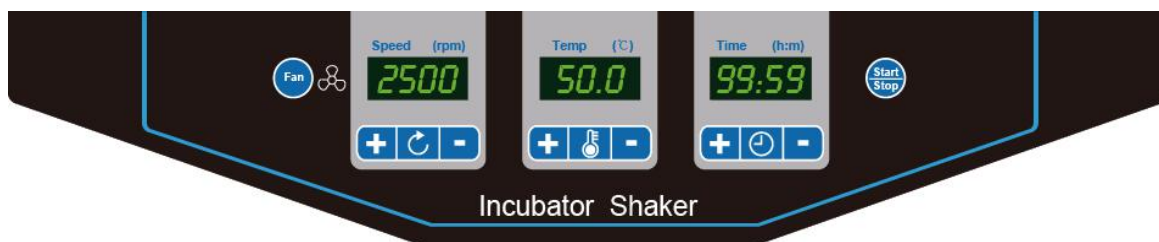

3. Description of operation buttons



Increase the speed, temperature or time setting value



Decrease the speed, temperature or time setting value

FAN

Key to switch display between shaking speed and fan speed. The indicator lights, the display speed is the fan speed. Fan speed can be adjusted.

START/STOP

Key to start or stop operation. Press Start/Stop key to start the operation. Keep press Start/Stop key around 2 seconds during operating to stop operation.

4. Power Connection

Put the instrument on a horizontal and even working table. Connect power as below figure. Voltage should be 110V or 220V based on the sticker notice.

AC110 / 220V



5. Equipped platform

SIS-60 + can be equipped with SPW-260 platform



SPW-260

Chapter 4 Operation Guide

1. Speed, Time and Temperature Setting

- a) All digital of LED display **8** as the right chart when power on. The instrument enters into the initial program with beep.



Press ▲ or ▼ of speed key. It displays last running speed. Refer to the right chart, it is “200” rpm. The unit digit flickers. Press ▲ or ▼ of speed key to adjust the speed value. Continuously pressing leads the value to increase or decrease from unit digit, tens digit to hundreds digit. E.g., to set the speed to 250rpm, continuously press ▲ till speed value displays “250”, release the ▲ key. The instrument confirms and saves the setting value “250”.

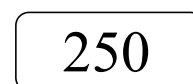
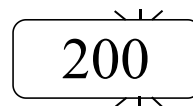

Press FAN key, the indicator is lighting, display speed changed from shaking speed to fan speed. Press ▲ or ▼ of speed key. It displays last setting speed of fan. Refer to the right chart, it is “3200” rpm. The unit digit flickers. Press ▲ or ▼ of speed key to adjust the speed value. Adjust step is 200rpm.

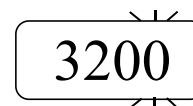

E.g., Press ▼ to change fan speed from 3200 to 2800rpm.

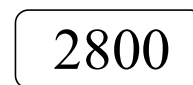

- b) Press ▲ or ▼ of time key. It displays last setting time. Refer to the right chart, it is “00:35” (timing is 35 minutes). The last digit flickers. Press ▲ or ▼ of time key to adjust the timing value. Continuously pressing leads the value increase or decrease in X10 speed.

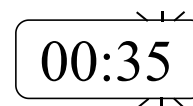

E.g., to set the timing at 1hour 20 minutes, press ▲ until time value displays “01:20”,

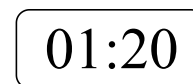

- c) Press ▲ or ▼ of temperature key. It displays last setting temperature. Refer to the right chart, it is “040.0” (temperature is 40°C). The last digit flickers. Press ▲ or ▼ of time key to adjust the temperature value. Continuously pressing leads the value increase or decrease in X10 speed.

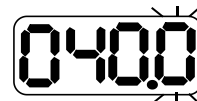

E.g., to set the temperature to 55.5°C, press ▲ until time value displays “055.5”,



NOTICE: Set the time at 00:00 means the operation time is ∞.

2. Start / Stop

- Press “start/stop” key to start the operation.
- Press “start/stop” to run the program after finish speed, time and temperature setting. When program completes, instrument stops running and alerts.
- Keep press “start/stop” around 2 seconds to stop the running program.
- When the program completes, or program stopped by pressing “start/stop” key, the instrument will be in stand-by mode. In stand-by mode, press ▲ or ▼ of speed, time or temperature key to reset setting value.
- Press “start/stop” directly without adjust any value in stand-by mode, the instrument operates the program as last setting.

Chapter 5 Failure Analysis and Trouble Shooting

Failure Analysis and Processing Procedures

No.	Phenomenon	Possible Causes	Processing Procedure
1	No signal display when power on.	No power	Check the power
		Broken fuse	Exchange the fuse (250V 3.0A Φ 5x20)
		Broken switch	Exchange the switch
		Others	Contact with the seller
2	The actual and displayed temperatures are much different.	Broken sensor	Contact with the seller
3	"OPEN" in the temperature display with the alarm of beep.	Temperature sensor is broken or ambient temperature is below 0°C	Contact with the seller
4	Hearing but no shaking	Broken motor or broken connecting line.	Contact with the seller
5	Press invalid	Broken press button	Contact with the seller
6	No hearing with the alarm of beep.	Transparency cover is not closed	Close the transparency cover

Appendix A: Wiring Diagram of Incubator Shaker

(Below diagram is just for reference. It is subject to change without prior notice.)

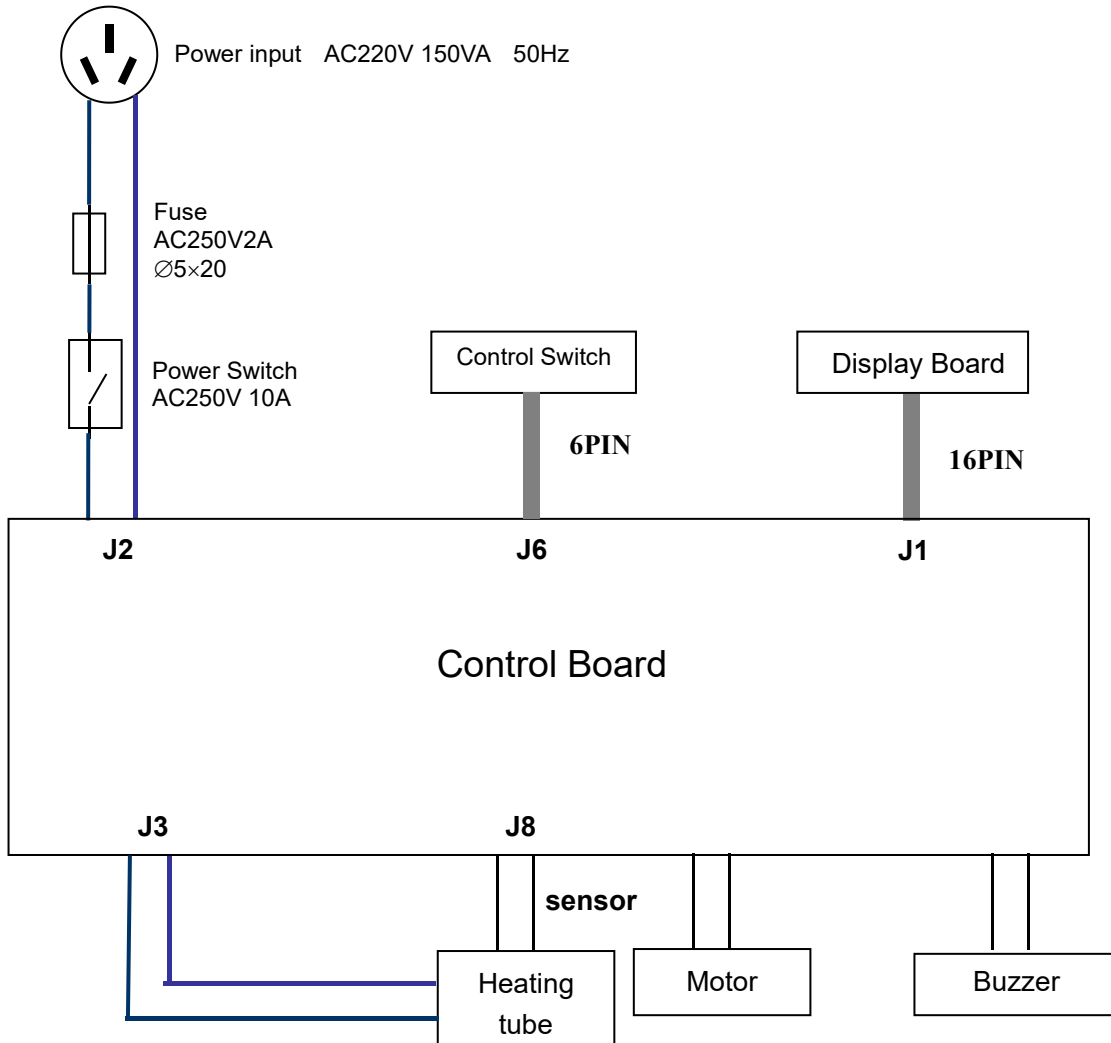

NOTE

